

YAMAHA AVX-100U

Natural Sound Stereo Amplifier

Comprehensive 8-Mode Digital Surround Processor

4/5-Channel Operation for Surround Sound Enjoyment

Superior Multi-Function Input/Output Control With 10 Audio and 6 Video Inputs

Independent Record-Out Selection

Video Enhancer

Superimposition Function

Title Editing Feature

Fully Integrated Remote Control System

Thank you for purchasing the YAMAHA AVX-100U stereo amplifier.

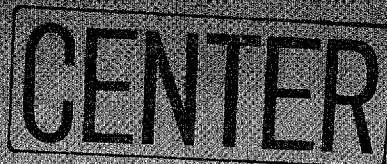

CONTENTS

SAFETY INSTRUCTIONS	1
CAUTION: READ THIS BEFORE OPERATING YOUR AVX-100U	2
SUPPLIED ACCESSORIES	3
REAR PANEL PARTS AND THEIR FUNCTIONS	4
SYSTEM POSSIBILITIES	7
CONNECTIONS	11
FRONT PANEL PARTS AND THEIR FUNCTIONS	20
USING THE REMOTE CONTROL TRANSMITTER	25
BASIC OPERATIONS	29
USING THE VIDEO ENHANCER	33
USING THE SURROUND SOUND PROCESSOR	36
SPECIFICATIONS	41
TROUBLESHOOTING	43

OWNER'S MANUAL



IMPORTANT

Please check your unit's rear panel serial number and record it in the space below.

Model: **AVX-100U**

Serial No.:

Keep this owner's manual in a safe place for future reference.

SAFETY INSTRUCTIONS

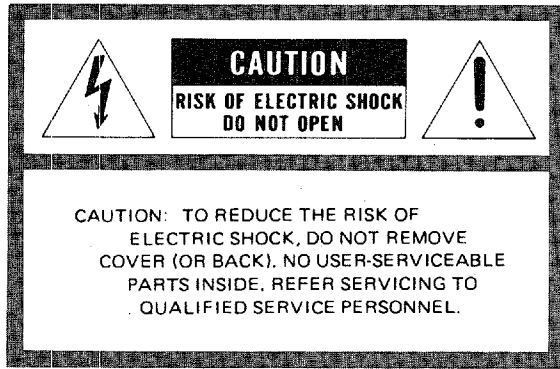

• Explanation of Graphical Symbols

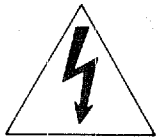

The lightning flash with arrowhead symbol, within an equilateral triangle, is intended to alert you to the presence of uninsulated "dangerous voltage" within the product's enclosure that may be of sufficient magnitude to constitute a risk of electric shock to persons.



The exclamation point within an equilateral triangle is intended to alert you to the presence of important operating and maintenance (servicing) instructions in the literature accompanying the appliance.

WARNING

To prevent fire or shock hazard, do not expose this appliance to rain or moisture.

1 Read Instructions — All the safety and operating instructions should be read before the appliance is operated.

2 Retain Instructions — The safety and operating instructions should be retained for future reference.

3 Heed Warnings — All warnings on the appliance and in the operating instructions should be adhered to.

4 Follow Instructions — All operating and other instructions should be followed.

5 Water and Moisture — The appliance should not be used near water — for example, near a bathtub, washbowl, kitchen sink, laundry tub, in a wet basement, or near a swimming pool, etc.

6 Carts and Stands — The appliance should be used only with a cart or stand that is recommended by the manufacturer.

7 Wall or Ceiling Mounting — The appliance should be mounted to a wall or ceiling only as recommended by the the manufacturer.

8 Ventilation — The appliance should be situated so that its location or position does not interfere with its proper ventilation. For example, the appliance should not be situated on a bed, sofa, rug, or similar surface, that may block the ventilation openings; or cabinet that may impede the flow of air through the ventilation openings.

9 Heat — The appliance should be situated away from heat sources such as radiators, stoves, or other appliances that produce heat.

10 Power Sources — The appliance should be connected to a power supply only of the type described in the operating instructions or as marked on the appliance.

11 Power-Cord Protection — Power-supply cords should be routed so that they are not likely to be walked on or pinched by items placed upon or against them, paying particular attention to cords at plugs, convenience receptacles, and the point where they exit from the appliance.

12 Cleaning — The appliance should be cleaned only as recommended by the manufacturer.

13 Nonuse Periods — The power cord of the appliance should be unplugged from the outlet when left unused for a long period of time.

CAUTION: READ THIS BEFORE OPERATING YOUR AVX-100U

14 Object and Liquid Entry — Care should be taken so that objects do not fall into and liquids are not spilled into the inside of the appliance.

15 Damage Requiring Service — The appliance should be serviced by qualified service personnel when:

- A. The power-supply cord or the plug has been damaged; or
- B. Objects have fallen, or liquid has been spilled into the appliance; or
- C. The appliance has been exposed to rain; or
- D. The appliance does not appear to operate normally or exhibits a marked change in performance; or
- E. The appliance has been dropped, or the cabinet damaged.

16 Servicing — The user should not attempt to service the appliance beyond those means described in the operating instructions. All other servicing should be referred to qualified service personnel.

17 Power Lines — An outdoor antenna should be located away from power lines.

18 Grounding or Polarization — The precautions that should be taken so that the grounding or polarization of an appliance is not defeated.

1. To ensure the finest performance, please read this manual carefully. Keep it in a safe place for future reference.

2. Install your unit in a cool, dry, clean place—away from windows, heat sources, and too much vibration, dust, moisture, or cold. Avoid sources of hum (transformers, motors.). To prevent fire or electrical shock, do not expose to rain and water.

3. Do not operate the amplifier upside-down. It may overheat, possibly causing damage.

4. Never open the cabinet. If a foreign object drops into the set, contact your dealer.

5. Do not place records or other objects on top of the amplifier; this will block the ventilation holes, cause the internal temperature to rise and may result in a failure.

6. Do not use force on switches, knobs or cords. When moving the set, first turn the unit off. Then gently disconnect the power plug and the cords connecting to other equipment. Never pull the cord itself.

7. Do not attempt to clean the unit with chemical solvents; this might damage the finish. Use a clean, dry cloth.

8. Be sure to read the "troubleshooting" section on common operating errors before concluding that your unit is faulty.

9. Do not connect audio equipment to the AC outlets on the rear panel if that equipment requires more power than the outlets are rated to provide.

SUPPLIED ACCESSORIES

After unpacking, check that the following parts are contained.

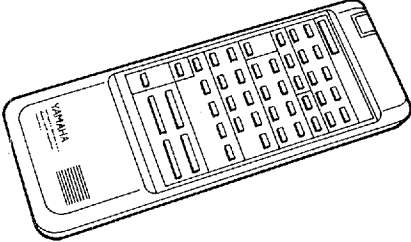
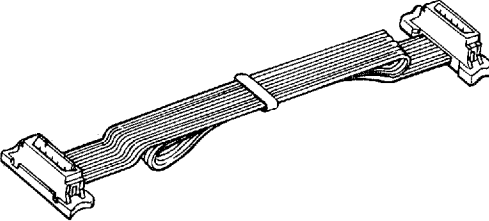
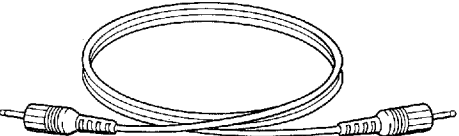
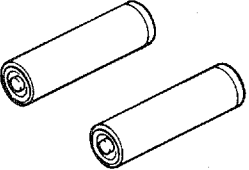
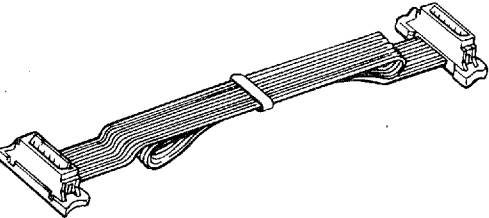
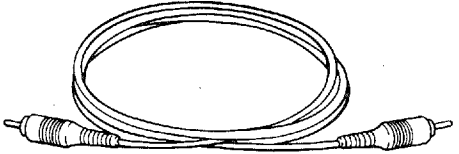
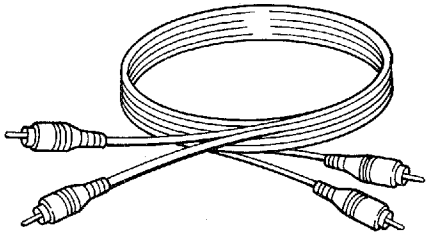
<ul style="list-style-type: none">• Remote control transmitter (RS-AVX100) 	<ul style="list-style-type: none">• Remote control cable (5-pin, tuner) 	<ul style="list-style-type: none">• Remote control cable (mini-plug, turntable) 
<ul style="list-style-type: none">• Batteries (size "AA") 	<ul style="list-style-type: none">• Remote control cable (6-pin, cassette deck) 	<ul style="list-style-type: none">• Video Cord 
<ul style="list-style-type: none">• Audio Cord 		

REAR PANEL PARTS AND THEIR FUNCTIONS

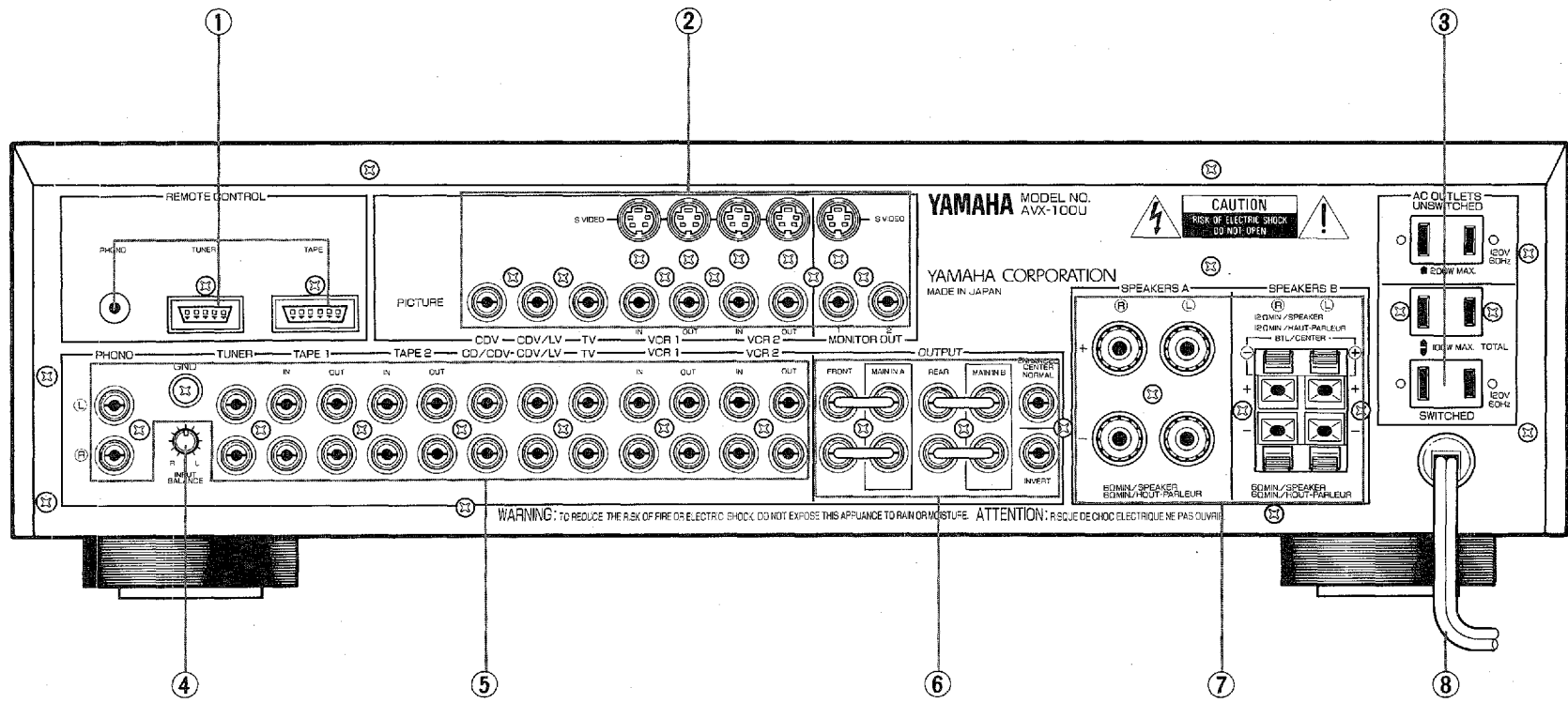

① **REMOTE CONTROL cable connectors**

These connectors are used to connect compatible YAMAHA components (with an *RS* mark) to your amplifier for remote control of each component. The cables for each component are supplied with this unit.

PHONO — Connect to a turntable using the cable with mini-plug connectors.

TUNER — Connect to a tuner using the cable with 5-pin connectors.

TAPE — Connect to a cassette tape deck using the cable with 6-pin connectors.

② **Video signal jacks**

These jacks are used to connect the video signal cables from your components to the amplifier. They should be connected to the proper input/output jacks for each unit.

CDV — Connect to a CD Video player.

CDV/LV — Connect to a CD Video player or to a Laservision player.

TV — Connect to a TV tuner.

VCR 1 — Connect to a Video Cassette Recorder for both recording and playback.

VCR 2 — Connect to a second Video Cassette Recorder for both recording and playback.

MONITOR OUT 1 — Connect to the video IN terminal on a video monitor.

MONITOR OUT 2 — Connect to the video IN terminal on a second video monitor.

● **S VIDEO connectors**

* With the S VIDEO connections, a high resolution picture will be obtained, resulting in much clearer reproduction.

S VIDEO VCR 1 connectors — Connect to a Video Cassette Recorder that has S connectors for both recording and playback.

S VIDEO VCR 2 connectors — Connect to a second Video Cassette Recorder that has S connectors for both recording and playback.

S VIDEO MONITOR connector — Connect to the S input connector on a video monitor.

③ **AC OUTLETS**

These outlets are used to connect the power cords from your components to the amplifier.

The power to the SWITCHED outlets is controlled by the amplifier's power switch. They will supply power to any component that is connected to them whenever the amplifier is turned on, whether by the front panel POWER switch or by the remote control unit POWER button. The total maximum power consumption of the components attached to these outlets must not exceed 100 watts.

The power to the UNSWITCHED outlet is not controlled by the amplifier. It will continually supply power to any unit connected to it. The total maximum power consumption of the component attached to this outlet must not exceed 200 watts. Note that the AC outlets are size-coded for polarity, so be sure to insert the plugs correctly.

④ **INPUT BALANCE control**

Used to obtain the best surround condition. Adjust this control so that the center sound from the rear speakers is at a minimum.

⑤ Audio signal connection jacks

These jacks are used to connect the audio signal cables from your components to the amplifier. They should be connected to the proper input/output jacks for each unit. Be sure that the L and R channels are connected correctly.

PHONO — Connect to a turntable equipped with an MM-type cartridge.

GND — Connect to the ground wire from the turntable.

TUNER — Connect to a tuner.

TAPE 1 — Connect to a cassette tape deck.

TAPE 2 — Connect to a second audio tape deck.

CD/CDV·CDV/LV — Connect to a Compact Disc player, CD Video player, or Laservision player.

TV — Connect to a TV tuner.

VCR 1 — Connect to a Video Cassette Recorder for both recording and playback.

VCR 2 — Connect to a second Video Cassette Recorder for both recording and playback.

⑥ OUTPUT jacks

These jacks allow a number of system connection possibilities. The bars that connect the REAR jacks to the MAIN IN B jacks and the FRONT jacks to the MAIN IN A jacks may be left as is, removed, or changed according to the system configuration you select. See the Connections section for a detailed explanation of how these jacks are used for each system configuration.

⑦ SPEAKER terminals

These terminals are used to connect up to two pairs of speakers. See the Connections section for details on the speaker connections.

⑧ AC power cord

This cord is used to connect the amplifier to an AC wall outlet.

SYSTEM POSSIBILITIES

There are four basic system configurations in which this unit may be used.

(1) This unit can be used as an Integrated Amplifier in a 4-Speaker System

In this configuration, the unit functions strictly as an integrated amplifier, controlling all of the audio and video components, and driving two pairs of speakers.

To set up this system:

1. Connect the supplied shorting bars between the MAIN IN A jacks and the FRONT jacks, and between the MAIN IN B jacks and the REAR jacks in the OUTPUT section on the rear panel of this unit.
 2. Connect the front speakers to the SPEAKERS A terminals and the rear speakers to the SPEAKERS B terminals on the rear panel of this unit.
- * Follow the speakers connection procedures, outlined later in the CONNECTION section.

4-Speaker System

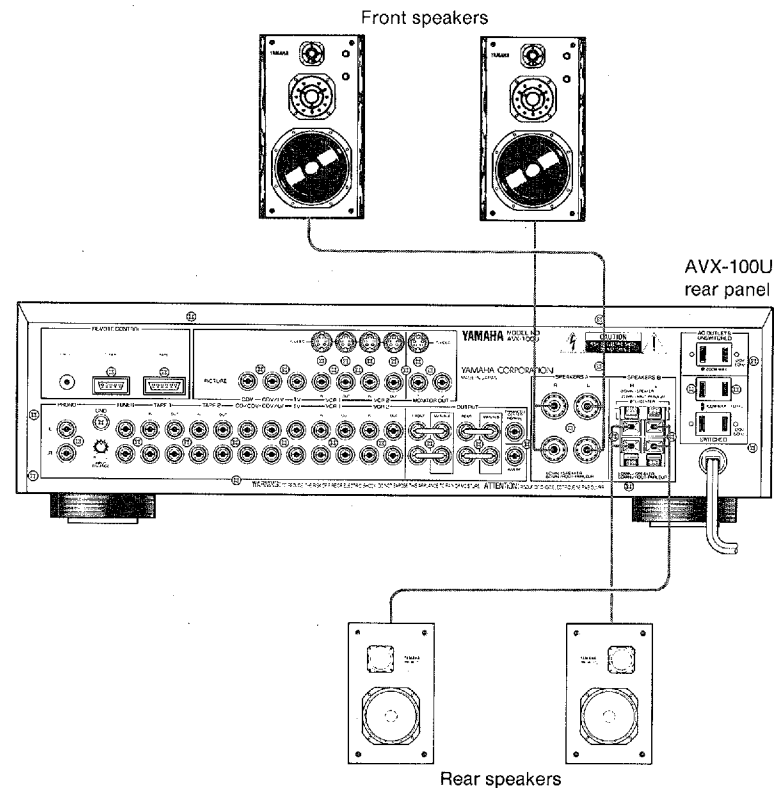

(2) This unit can be used as an Integrated Amplifier in a 6-Channel System, using a power amplifier for the center speakers.

In this configuration, the unit functions as a preamplifier, controlling all of the audio and video components in your system, and as a power amplifier for a pair of front speakers and a pair of rear speakers. Another power amplifier is necessary to drive the center speakers.

- This is the recommended system configuration, as it allows you to take full advantage of the AVX-100's capabilities.

To set up this system:

1. Connect the supplied shorting bars between the MAIN IN A jacks and the FRONT jacks, and between the MAIN B jacks and the REAR jacks in the OUTPUT section on rear panel of this unit.
2. Connect the ENHANCED CENTER NORMAL jack to the left INPUT jack and the INVERT jack to the right INPUT jack of a power amplifier.

* If your system's power amplifier is an integrated amplifier or receiver, the ENHANCED CENTER NORMAL and INVERT jacks may be connected to the TAPE IN jacks, the AUX jacks, or any component input jacks other than PHONO. That signal must then be selected by the integrated amplifier's or receiver's front panel INPUT SELECTOR.

The ENHANCED CENTER NORMAL and INVERT jacks on the rear panel of this unit send the audio signals to your system's power amplifier or receiver to drive the center speakers.

3. Connect the front speakers to the SPEAKERS A terminals and the rear speakers to the SPEAKERS B terminals on the rear panel of this unit.
- * Follow the speaker connection procedures as outlined later in the CONNECTIONS section.

4. Connect the center speakers to the speaker terminals of your system's power amplifier, integrated amplifier or receiver.

For the speaker to be connected to the L speaker terminals, connect the positive (+) speaker wire to the positive (+) speaker terminal and the negative (-) speaker wire to the negative (-) speaker terminal. For the speaker to be connected to the R speaker terminals, connect the positive (+) speaker wire to the negative (-) speaker terminal and the negative (-) speaker wire to the positive (+) speaker terminal.

- When using a monaural amplifier to drive a center speaker, connect the ENHANCED CENTER NORMAL jack to the INPUT jack of the amplifier, and connect the center speaker to the speaker terminals of the amplifier. In this case, connect the positive (+) speaker wire to the positive (+) speaker terminal and the negative (-) speaker wire to the negative (-) speaker terminal.

This unit driving front and rear speakers while another amplifier or receiver driving center speakers

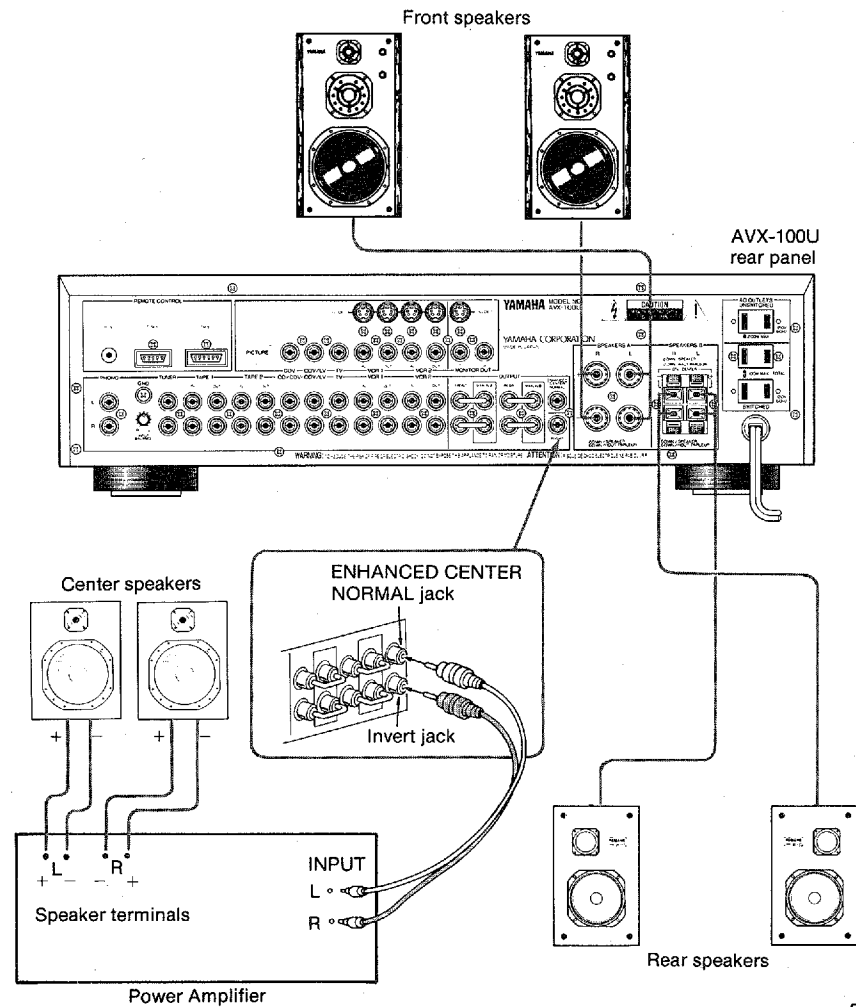

(3) This unit can be used as an Integrated Amplifier in a 5-Speaker System using a power amplifier for the rear speakers.

In this configuration, the unit functions as a preamplifier, controlling all of the audio and video components in your system, and as a power amplifier for a pair of front speakers and center speaker. Another power amplifier is necessary to drive the rear speakers.

To set up this system:

1. Connect the supplied shorting bars between the MAIN IN A jacks and the FRONT jacks, and between the MAIN B IN jacks and the ENHANCED CENTER NORMAL jack and the INVERT jack in the OUTPUT section on the rear panel of this unit.
2. Connect the REAR OUTPUT jacks to the INPUT jacks of a power amplifier.

* If your system's power amplifier is an integrated amplifier or receiver, the REAR OUTPUT jacks may be connected to the TAPE IN jacks, the AUX jacks, or any component input jacks other than PHONO.

That signal must then be selected by the integrated amplifier's or receiver's front panel INPUT SELECTOR.

The REAR OUTPUT jacks on the rear panel of this unit send the audio signals to your system's power amplifier to drive the rear speakers.

3. Connect the front speakers to the SPEAKERS A terminals and center speaker to the BTL/CENTER \ominus and \oplus of the SPEAKERS B terminals on the rear panel of this unit.

* Follow the speaker connection procedures as outlined later in the CONNECTIONS section.

4. Connect the rear speakers to the speaker terminals of your system's power amplifier.

This unit driving a pair of front speakers and center speaker while another amplifier driving rear speakers

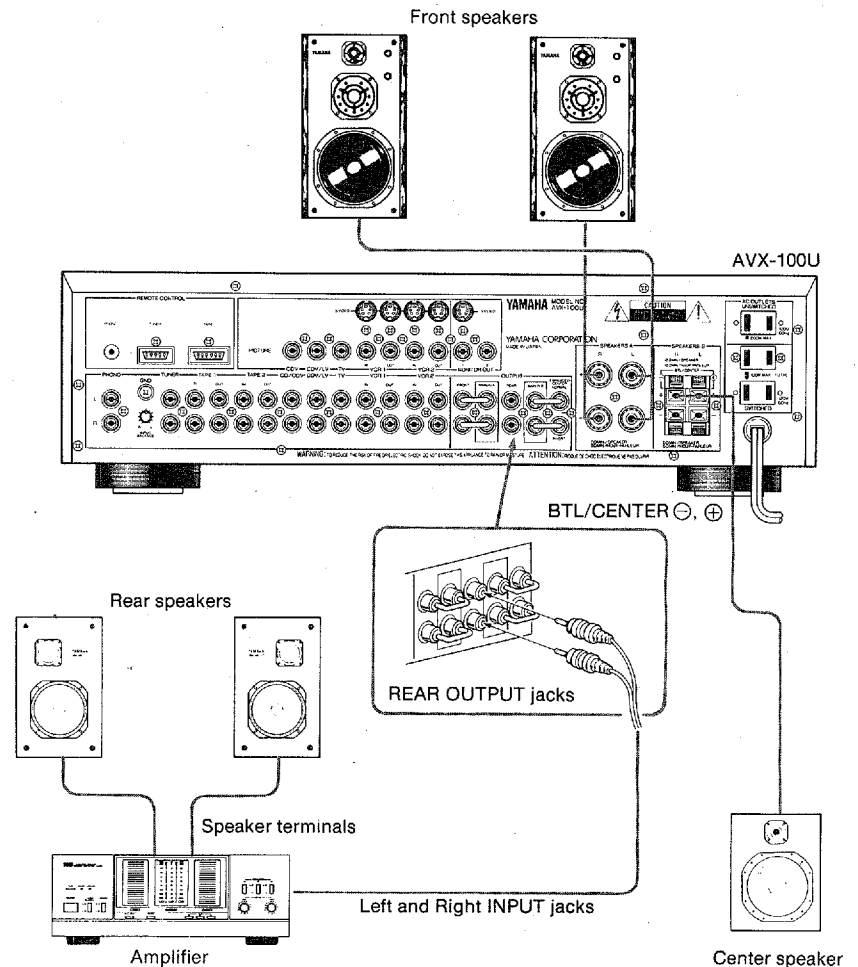

(4) This unit can be used as an Integrated Amplifier in a 5-Speaker System using a power amplifier for the front speakers (if, for example, the other amplifier is a stronger one).

In this configuration, the unit functions as a preamplifier, controlling all of the audio and video components in your system, and as a power amplifier for a pair of rear speakers and a center speaker.

Another power amplifier, stronger than this unit, is necessary to drive the front speakers.

To set up this system:

1. Connect the supplied shorting bars between the MAIN IN A jacks and the REAR jacks, and between the MAIN IN B jacks and ENHANCED CENTER NORMAL jack and INVERT jack in the OUTPUT section on the rear panel of this unit.
2. Connect the FRONT OUTPUT jacks to the INPUT jacks of a power amplifier.
 - * If your system's power amplifier is an integrated amplifier, the FRONT OUTPUT jacks may be connected to the TAPE IN jacks, the AUX jacks, or any component input jacks other than PHONO. That signal must then be selected by the integrated amplifier's front panel INPUT SELECTOR.

The FRONT OUTPUT jacks on the rear panel of this unit send the audio signals to your system's power amplifier to drive the front speakers.
3. Connect the rear speakers to the SPEAKERS A terminals and center speaker to the BTL/CENTER \ominus and \oplus of the SPEAKERS B terminals on the rear panel of this unit.
 - * Follow the speaker connection procedures as outlined later in the CONNECTIONS section.
4. Connect the front speakers to the speaker terminals of your system's power amplifier.

This unit driving a pair of rear speakers and a center speaker while another power amplifier driving the front speakers

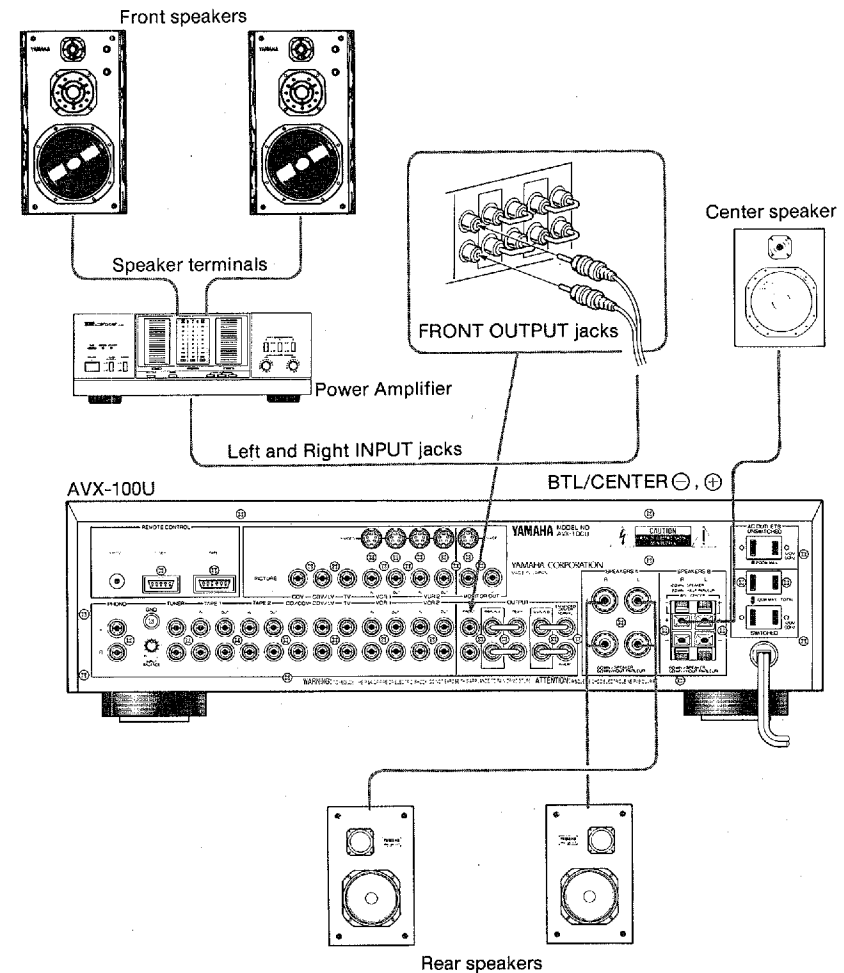

CONNECTIONS

System Connection Diagram

* Note that the remote control transmitter will directly operate some Tuners or Cassette Decks bearing the **ERS** mark. For these components, the remote control cable connections are not necessary.

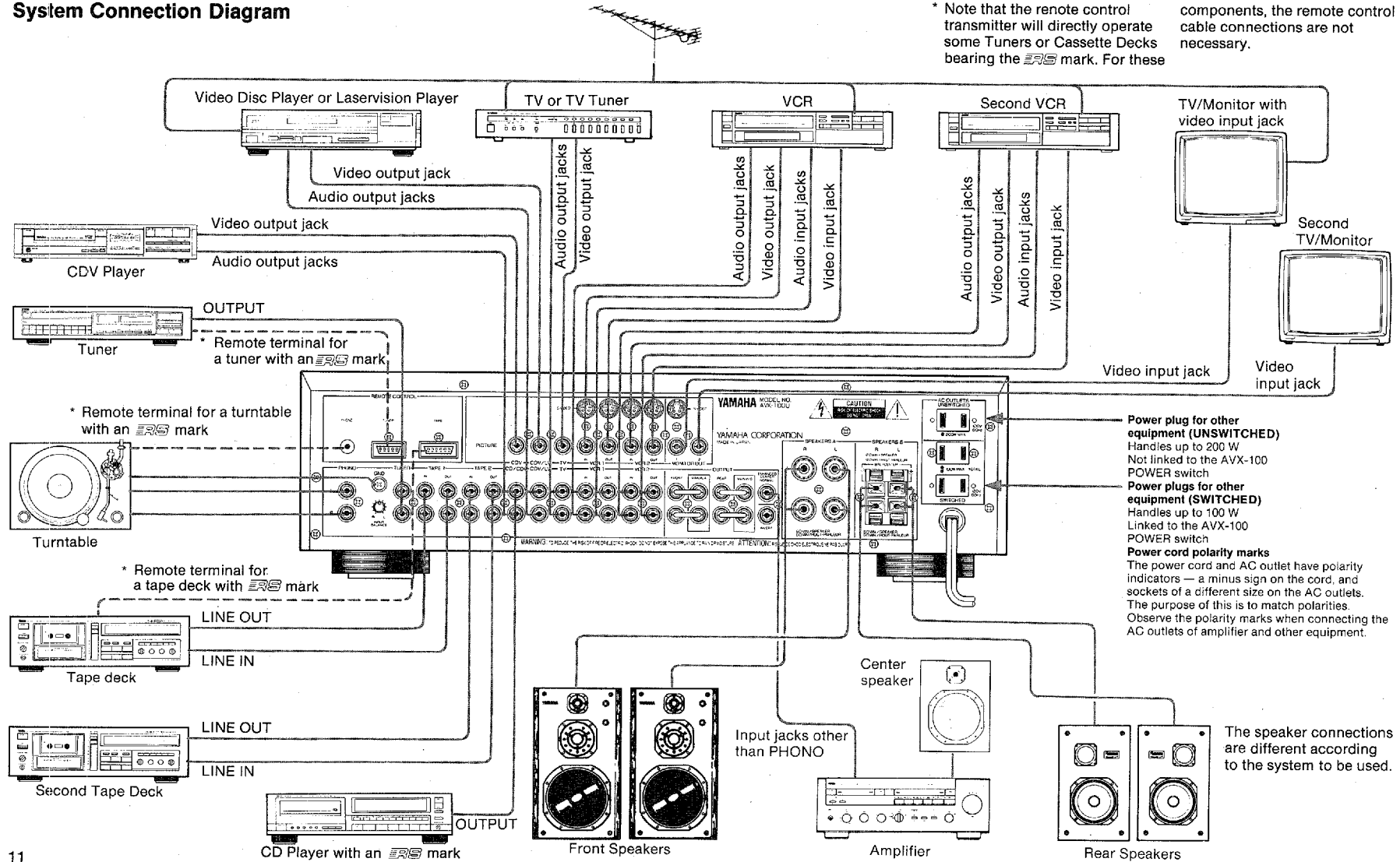

CONNECTIONS FOR EACH COMPONENT

- Remember to turn off the power to all of the units before making any connections.
- When making the connections, keep all cables well away from sources of hum, such as power cords or the power transformers in other components.

Notes on REMOTE CONTROL terminals

The REMOTE CONTROL terminals are used when you have YAMAHA compatible components bearing the *RS* mark. These terminals allow you to control the connected components with the supplied remote control transmitter.

Connect the remote control cables from the components to the correct terminals on your amplifier (i.e. PHONO, TUNER, TAPE).

Note that no cable is necessary for a CD or CDV player as the remote control transmitter operates the player directly.

AUDIO COMPONENTS

■ TURNTABLE

Connect the output cables of the turntable to the PHONO jacks, and connect the ground wire to the GND terminal on the rear panel of this unit. This should produce minimum hum, but in some cases better results are obtained with this wire disconnected. When a turntable bearing the *RS* mark is used, connect the remote control terminal on the turntable to the REMOTE CONTROL PHONO terminal on the rear panel of this unit, using the supplied remote cable with mini-plug connectors.

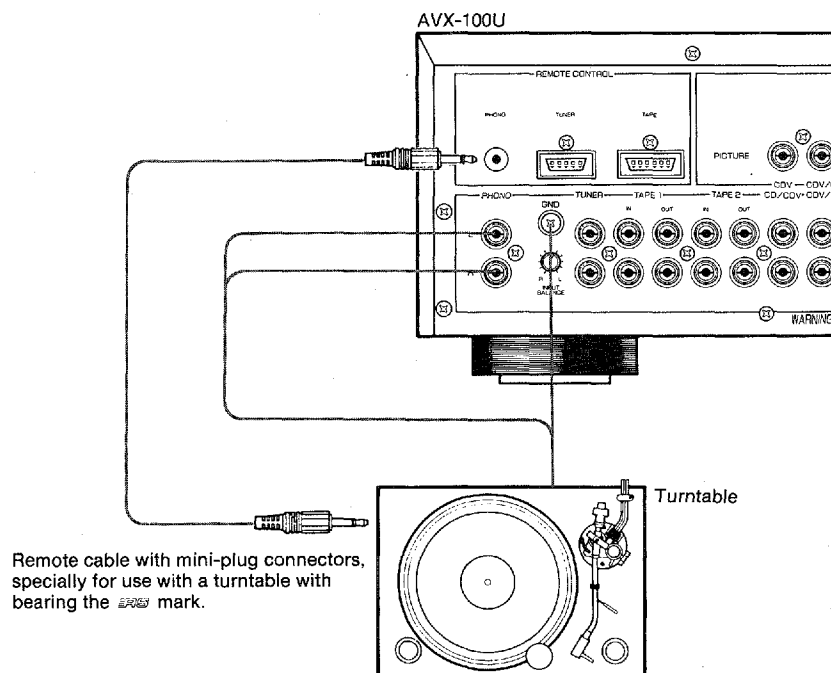

■ TUNER

Connect the output jacks of the tuner to the TUNER jacks on the rear panel of this unit.

When a tuner bearing the *ERS* mark is used, connect the remote control terminal on the tuner to the REMOTE CONTROL TUNER terminal on the rear panel of this unit, using the supplied 5-pin remote control cable.

* If your tuner bears the *ERS* mark, and it can be directly operated with the remote control transmitter, the remote control cable connections are not necessary.

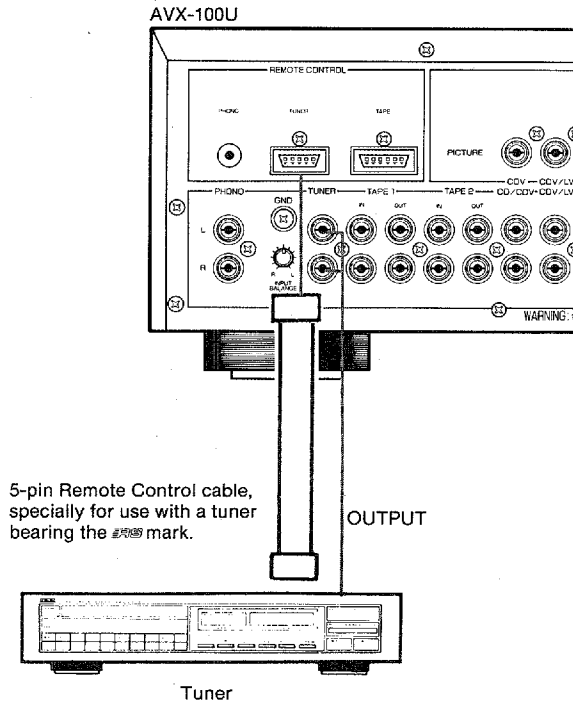

■ TAPE DECK

Connect the cables from a cassette deck, or other audio tape unit, to the TAPE 1 jacks, and connect a second cassette deck, or another audio tape unit, to the TAPE 2 jacks. The playback (LINE OUT) jacks of the cassette deck go to the IN jacks, and the record (LINE IN) jacks go to the OUT jacks on the rear panel of this unit. When a cassette deck bearing the *ERS* mark is used, connect the remote control terminal on the cassette deck to the REMOTE CONTROL TAPE terminal on the rear panel of this unit, using the supplied 6-pin remote control cable.

* If your cassette deck bears the *ERS* mark, and it can be directly operated with the remote control transmitter, the remote control cable connections are not necessary.

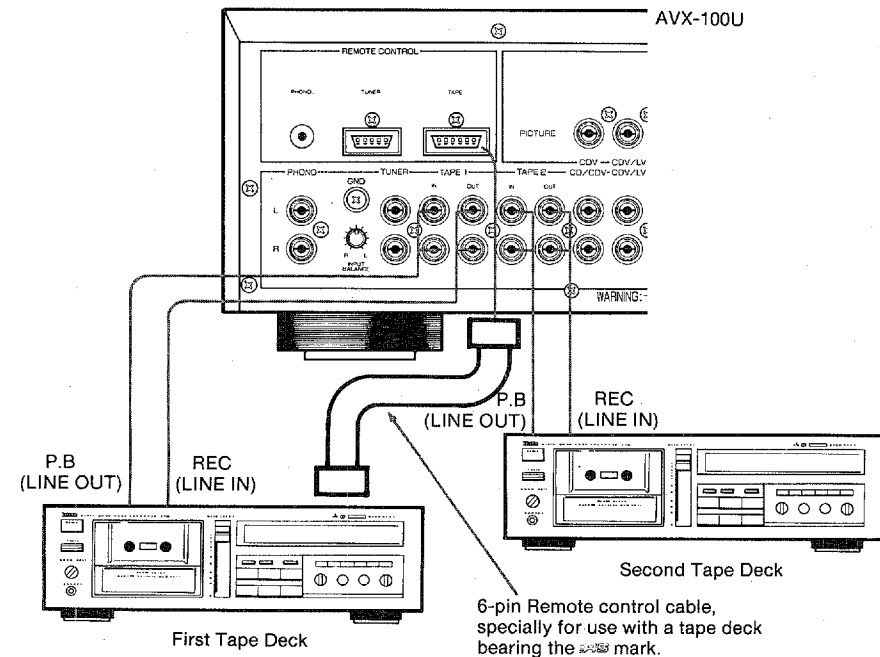

■ COMPACT DISC PLAYER

Connect the output jacks of the compact disc player to the CD/CDV audio jacks on the rear panel of this unit.

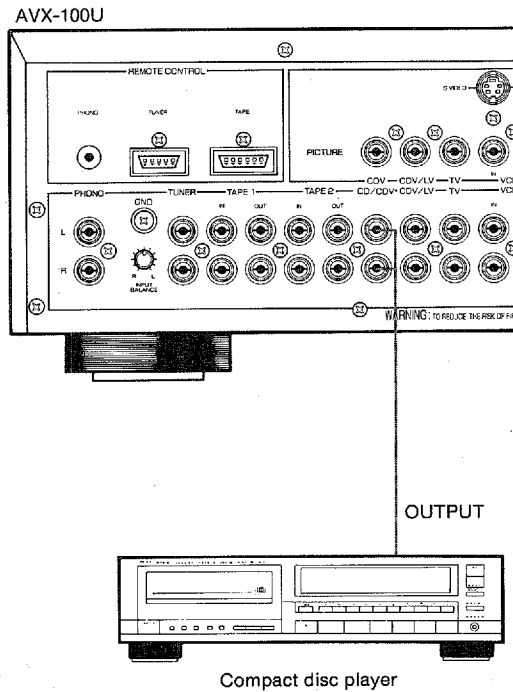

VIDEO COMPONENTS

■ CDV (CD Video) PLAYER

Connect the video output jack from the CDV player to the CDV jack in the PICTURE section of on the rear panel of this unit, and connect the audio output jacks from the CDV player to the CD/CDV audio jacks.

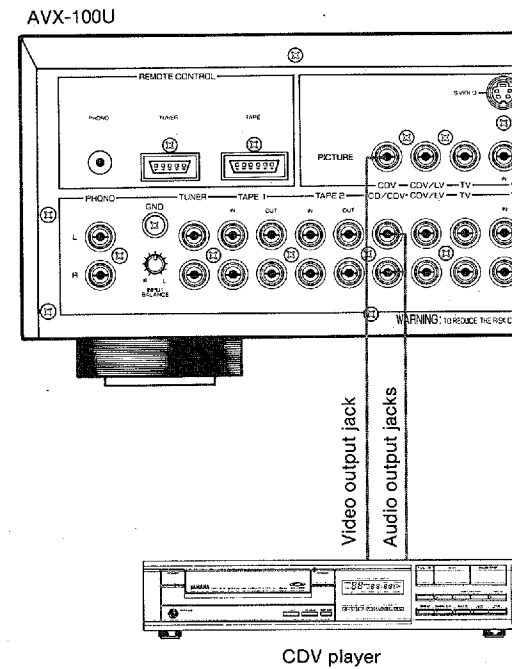

■ CDV/LV (Laser Vision) PLAYER

Connect the video output jack from the CDV/LV player to the CDV/LV jack in the PICTURE section on the rear panel of this unit and connect the audio output jacks from the CDV/LV player to the CDV/LV audio jacks.

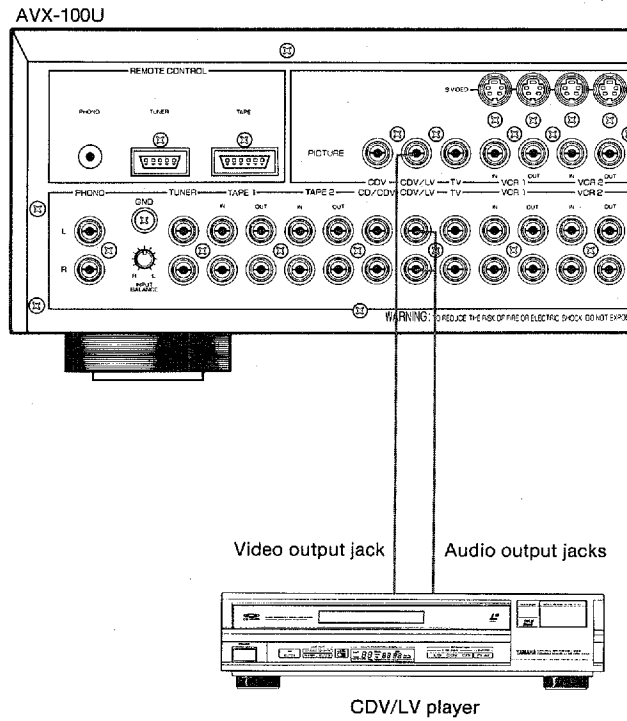

■ TV TUNER

Connect the video output jack from the TV or TV tuner to the TV jack in the PICTURE section on the rear panel of this unit and connect the audio output jacks from the TV or TV tuner to the TV audio jacks.

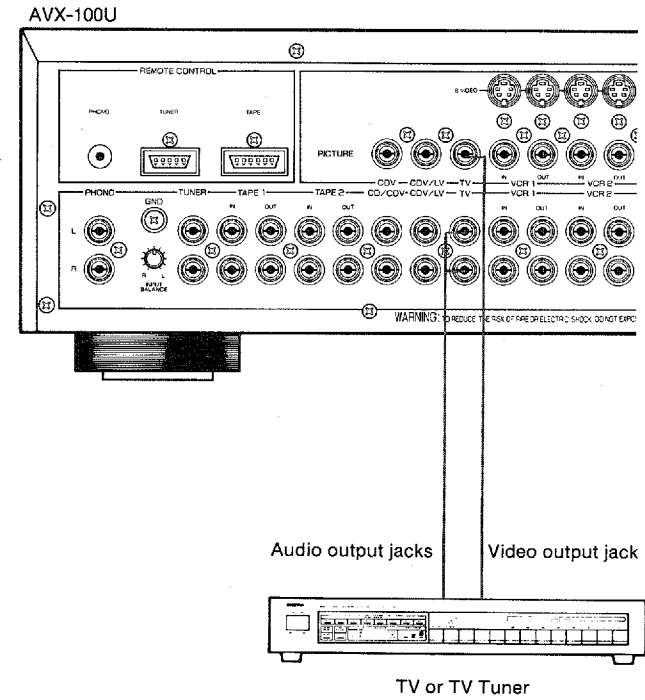

■ VCR (Video Cassette Recorder)

Connect the video jacks of the first VCR to the PICTURE VCR 1 jacks, and connect the video jacks of a second VCR to the PICTURE VCR 2 jacks on the rear panel of this unit. The video playback (VIDEO OUT) jack of the VCR goes to the PICTURE IN jack, and the video record (VIDEO IN) jack goes to the PICTURE OUT jack.

Connect the audio output jacks of the first VCR to the VCR 1 jacks, and connect the audio output jacks of a second VCR to the VCR 2 jacks. The audio playback (AUDIO LINE OUT) jacks of the VCR go to the audio IN jacks, and the audio record (AUDIO LINE IN) jacks go to the audio OUT jacks.

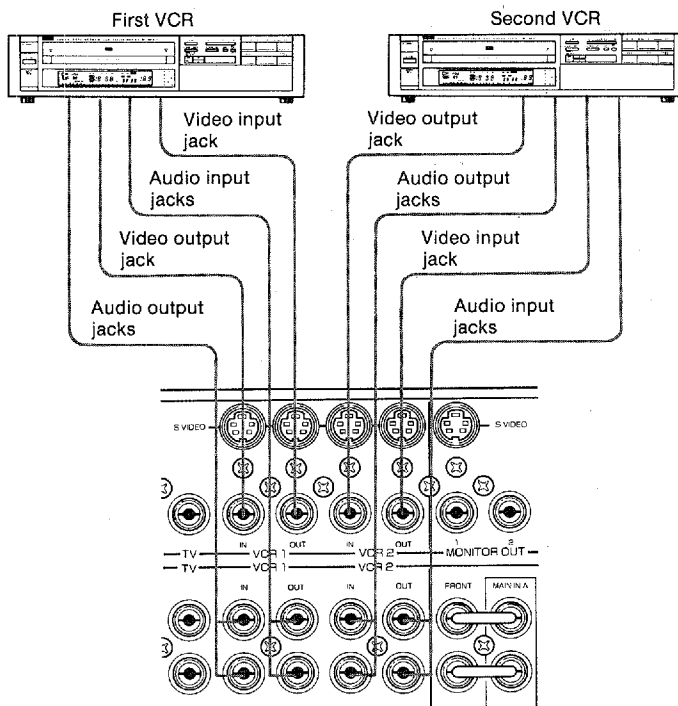

- When a VCR that has S connectors is used, connect the PICTURE S VIDEO connectors. With the S VIDEO connections, a high resolution picture will be obtained, resulting in much clearer reproduction. Connect the S output connector of the first VCR to the PICTURE S VIDEO IN connector in the VCR 1 section on the rear panel of this unit, and connect the S input connector of the first VCR to the PICTURE S VIDEO OUT connector.
- Keep the PICTURE VCR IN and OUT jacks, and audio IN and OUT jacks connected between the VCR and this unit. If the second VCR has S connectors, connect the S output and input connectors to the PICTURE S VIDEO IN and OUT connectors in the VCR 2 section on the rear panel of this unit in the same way.

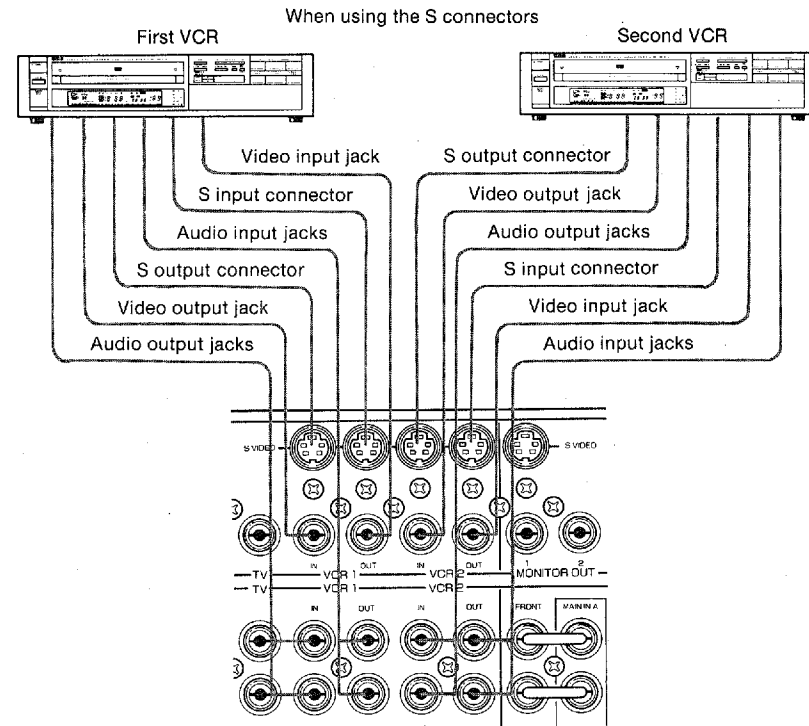

■ TV/MONITOR

Connect the video input jack from the first TV/Monitor to the MONITOR OUT 1 jack, and connect the video jack from a second TV/Monitor to the MONITOR OUT 2 jack on the rear panel of this unit. Note that audio output connections to the monitor are not necessary, as the audio portion of the signal is sent to your speakers through the amplifier.

- When a monitor that has an S video connector is used connect the S VIDEO MONITOR OUT 1 connector. With the S VIDEO connections, a high resolution picture will be obtained, resulting in much clearer reproduction.

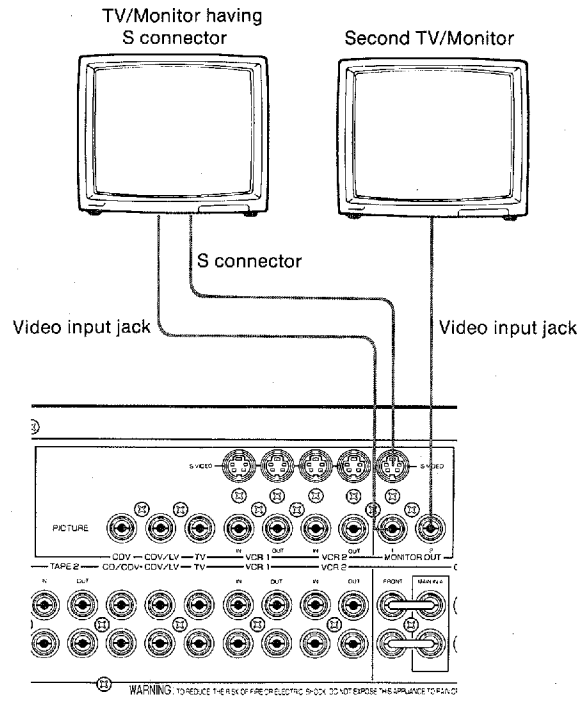

■ OTHER VIDEO SOURCE

If necessary, you can connect a third video input source, such as a camera, to the AUX jacks on the front panel of this unit. When connecting a mono audio source, connect it to the L jack.

SPEAKERS

You can connect two pairs of speakers to this unit. Follow these points to make the proper SPEAKERS A and SPEAKERS B terminal connections.

- * When connecting the speaker terminals to your speakers, use the proper gauge wire, cut as short as possible.
- * Make sure that the polarity of the speaker wires is correct, that is, that the + and - markings are observed. If these wires are reversed, the sound will be unnatural and will lack bass.
- * Do not coil up any excess speaker wire or bundle the speaker cables with the power cords.
- * Strip approximately 3/8" (10mm) of the insulation from the speaker cords (whatever their gauge).

Connections for the SPEAKERS A terminals

Turn the SPEAKERS A terminal connectors counterclockwise to loosen them, insert the stripped wire into the hole of the terminals, and then turn the connector clockwise until firm. The wires will be locked into position. If these connections are faulty, no sound will be heard from the speakers and your amplifier may be damaged.

- Speaker cords with Banana Plugs can also be used. In this case, rotate the connectors clockwise until firm.

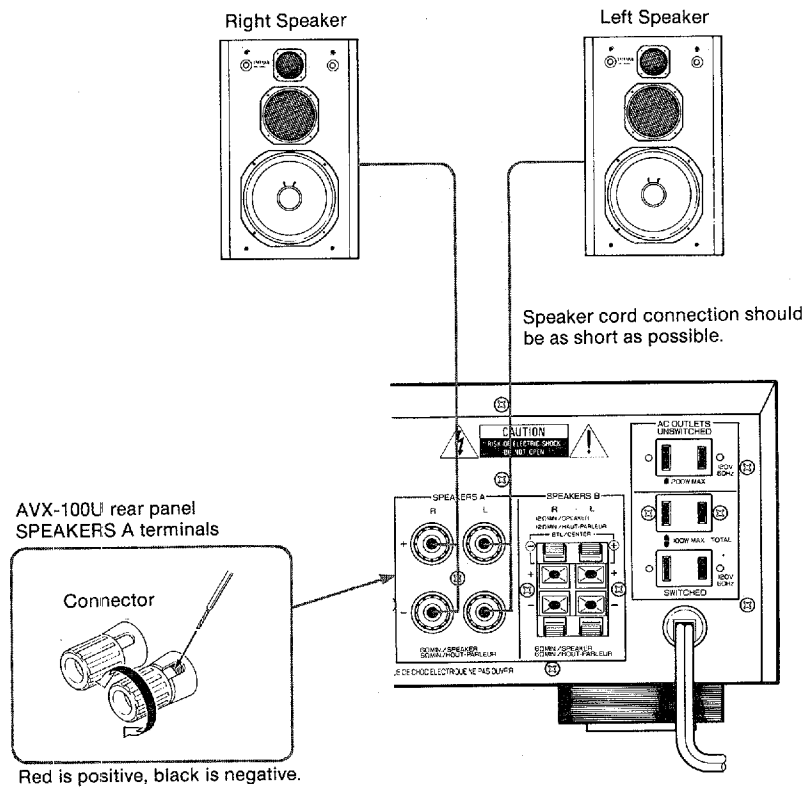

Connections for the SPEAKERS B terminals

Press the SPEAKER B terminal tabs down, insert the stripped wires and secure them by releasing the tabs. If these connections are faulty, no sound will be heard from the speakers and your amplifier may be damaged.

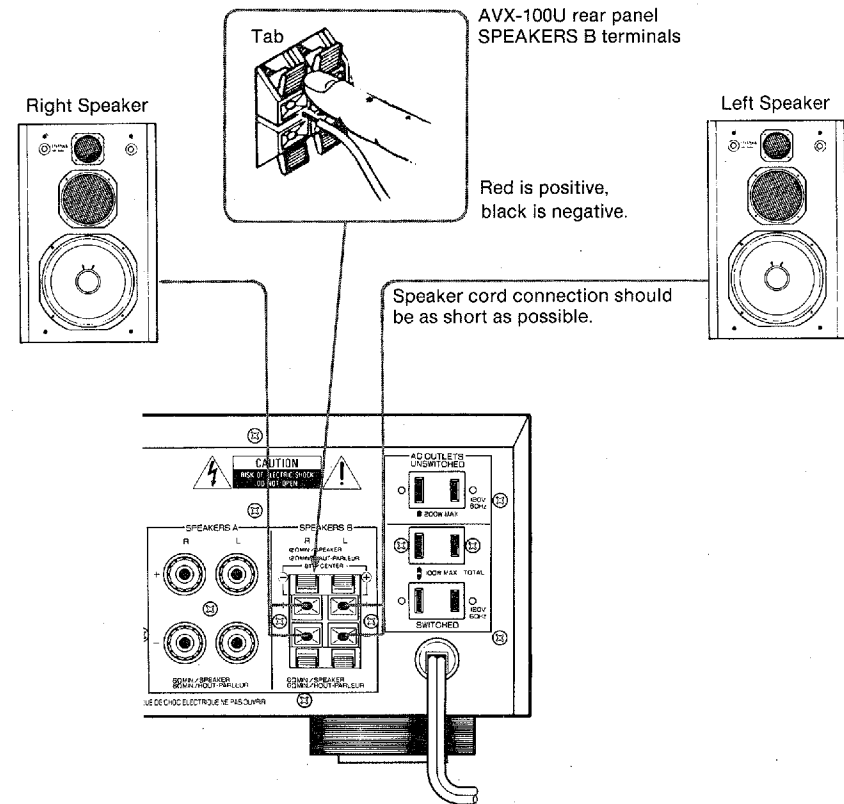

● **When connecting the center speaker to the SPEAKERS B terminals**

Connect the positive (+) speaker wire to the terminal marked BTL/CENTER ⊕. Connect the negative (-) speaker wire to the terminal marked BTL/CENTER ⊖.

Press the SPEAKERS B BTL/CENTER terminal tabs down, then insert the stripped wires and secure them by releasing the tabs. If these connections are faulty, no sound will be heard from the speaker and your amplifier may be damaged.

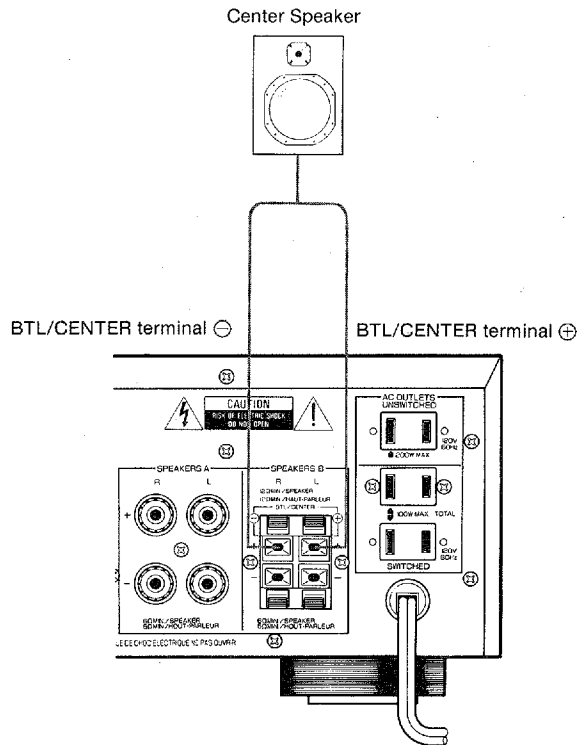

POWER CORDS

1. Connect the power cord of your tuner, cassette deck or other components to the SWITCHED AC OUTLETS to automatically switches on/off these components when the amplifier is turned on/off. The maximum total power consumption of the components connected to the SWITCHED AC OUTLETS must not exceed 100 watts.
2. Connect the power cord of your VCR or other unit to the UNSWITCHED AC OUTLET to supply power to it constantly. The maximum power consumption of the unit connected to the UNSWITCHED AC OUTLET must not exceed 200 watts.
3. Make sure that the power cords are not huddled together with the input/output cables.
4. Connect the power cord of your amplifier to an AC outlet.

FRONT PANEL PARTS AND THEIR FUNCTIONS

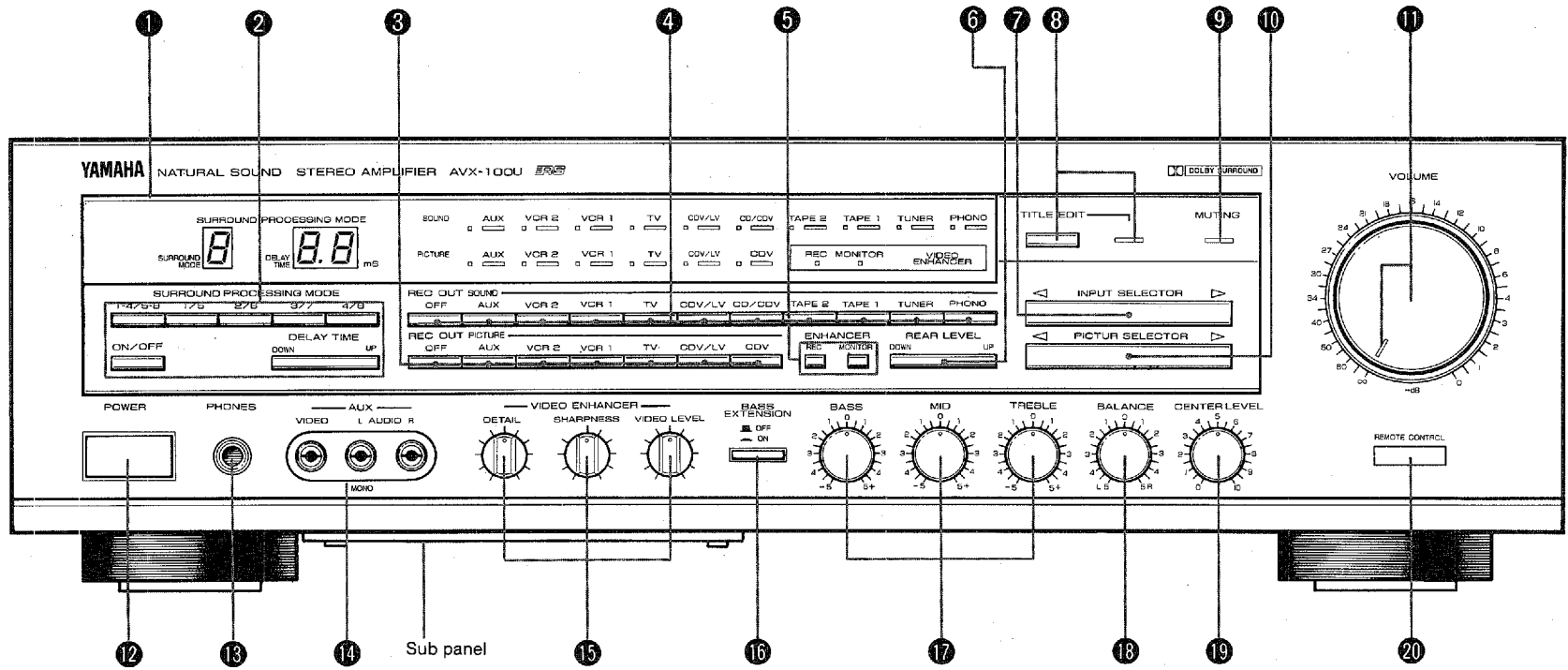

① Display window

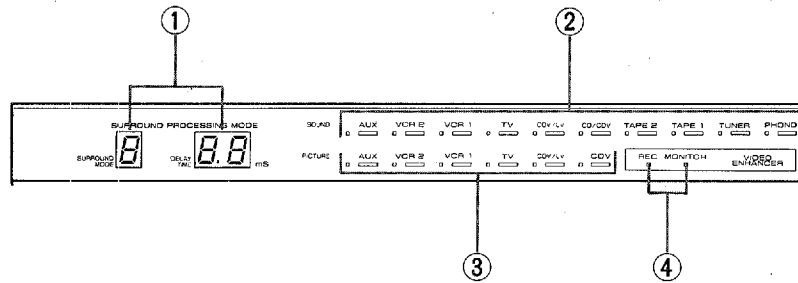

① SURROUND PROCESSING MODE display SURROUND MODE:

Displays the surround mode selected with the SURROUND PROCESSING MODE buttons.

DELAY TIME:

Displays the delay time from 0.0 mS to 30 mS, set with the DELAY TIME button.

② Input and rec out SOUND indicators

The rectangular indicators light in red to show which input SOUND is selected. The small square indicators at the left of the input SOUND indicators light to show which rec out SOUND is selected.

③ Input and rec out PICTURE indicators

The rectangular indicators light in green to show which input PICTURE is selected. The small square indicators at the left of the input PICTURE indicators light to show which rec out PICTURE is selected.

④ VIDEO ENHANCER REC and MONITOR indicators

Either the REC indicator or MONITOR indicator lights, showing which of the two signal is going to be enhanced.

② SURROUND PROCESSING MODE buttons

These buttons have a dual purpose: Surround processing mode setting and Title editing operations.

SURROUND PROCESSING MODE setting

* Be sure to set the TITLE EDIT button to off when setting the Surround processing mode.

These modes are effective only when this unit is driving a pair of rear speakers in a 4 or 5-channel system.

ON/OFF switch:

Set this switch to ON to enable the surround mode features. The SURROUND PROCESSING MODE display appears. When surround mode is not desired, set this switch to OFF. The SURROUND PROCESSING MODE display disappears.

1-4/5-8 button:

Press this button to select the surround mode range, between ranges "1-4" and "5-8".

1/5, 2/6, 3/7, 4/8 buttons:

These buttons are used to implement the following 8 surround sound features.

1	Natural Surround 1	5	Simulated Stereo Surround
2	Natural Surround 2	6	Simulated Surround
3	Hall Surround	7	Live Surround
4	Dolby Surround	8	Presence Delay Surround

Press one of these buttons to select one of the 8 surround modes. When the "1-4" surround mode range has been set with 1-4/5-8 button, the selected surround mode can be 1, 2, 3, or 4. When the "5-8" surround mode range has been set with 1-4/5-8 button, the selected surround mode can be 5, 6, 7, or 8.

DELAY TIME control:

This control is used to vary the audio time delay to the rear speakers from 0.0 to 30 milliseconds.

Title edit operation

These buttons are also used to edit a title to be recorded on the VCR. First, press the TITLE EDIT button for more than 1 second, until the blinking TITLE EDIT indicator lights steadily. Once the characters and the position of cursor appear on the monitor TV, you can edit a title with these buttons. The characters of the title can be selected from among the alphabetical, numerical and various other symbols. For details, see the "EDITING A TITLE" section.

③ REC OUT PICTURE selectors

These buttons are used to select the video source (CD Video player, Laservision player, Television, Video Cassette recorder 1 or 2, or other video component) to be sent to the video out recording jack (VCR 1 or 2 OUT) at the rear of this unit. This enables video recording of any source, even while monitoring another.

When video recording is not desired, press the OFF selector.

④ REC OUT SOUND selectors

These buttons are used to select the audio source (Turntable, Tuner, Tape deck 1, Tape deck 2, CD Video player, CD player, Laservision player, Television, Video cassette recorder 1, Video cassette recorder 2 or other audio/video component) to be sent to the audio REC OUT terminals. This enables audio recording of any source, even while monitoring another.

When audio recording is not desired, press the OFF selector.

⑤ ENHANCER REC and MONITOR buttons

These buttons are used to select the signal to be video enhanced. When the REC button is pressed, the signal being recorded is video enhanced. To clear this function, press the REC button again. The VIDEO ENHANCER REC indicator goes off. When the MONITOR button is pressed, the signal being monitored is video enhanced. To clear this function, press the MONITOR button again. The VIDEO ENHANCER MONITOR indicator goes off.

⑥ REAR LEVEL volume control

This control raises or lowers the volume level of the rear speakers. Press the UP side of the control to raise the volume level and press the DOWN side to lower it.

⑦ INPUT SELECTOR button

This button is used to select the sound of the audio or video source you wish to monitor (Turntable, Tuner, Tape deck 1, Tape deck 2, CD Video player, CD player, Laservision player, Television tuner, Video Cassette Recorder 1, Video Cassette Recorder 2, or Auxiliary).

* When the sound of a video source is selected, the picture of that video source is automatically selected. If you wish to watch something other than it, press the PICTURE SELECTOR button to select the desired picture.

⑧ TITLE EDIT button and indicator

This button is used to select the title editing function. To edit a title, first press this button for more than 1 second until the TITLE EDIT indicator lights steadily, and then operate the SURROUND PROCESSING MODE buttons.

⑨ Audio MUTING indicator

This indicator lights when Muting is engaged (from the remote control unit). By pressing the MUTE -20 dB key of the remote control transmitter, the sound level will be muted by 20 dB.

⑩ PICTURE SELECTOR buttons

This button is used to select the picture of the video source you wish to monitor (CD Video player, Laservision player, Television tuner, Video Cassette Recorder 1, Video Cassette Recorder 2, Auxiliary or OFF).

* When the sound of a video source is selected with the INPUT SELECTOR button, the picture of that video source is automatically selected. If you wish to watch something other than it, select the desired video source picture with the PICTURE SELECTOR button. When a picture is not desired, press the PICTURE SELECTOR button until none of the indicators is lit.

⑪ VOLUME control and power indicator

This control is used to adjust the output volume level. Turning the control clockwise increases the sound level, and turning it counterclockwise decreases the sound level. This control acts as the master volume control; it increases and decreases the volume level to both the front and rear speaker pairs. The built-in indicator lights when the POWER switch is turned on.

⑫ POWER switch

This switch is used to turn the power to the unit on and off. Press it to supply power. Press the switch again to turn the power off.

⑬ HeadPHONES jack

This jack is used to privately listen to the sound. Insert your headphone plug into it.

⑭ AUX jacks

These jacks are used to connect an auxiliary video/audio input source, such as a camera, to the amplifier.

⑮ VIDEO ENHANCER controls

These controls are used to enhance the video signal which is being recorded or monitored.

DETAIL control:

This control is used to compensate for loss of detail (i.e. to increase subtle texture and eliminate smearing).

SHARPNESS control:

This control is used to increase the sharpness of the picture (i.e. to sharpen the edges and contours).

VIDEO LEVEL control:

This control is used to increase or decrease the picture brightness.

⑯ BASS EXTENSION switch

This switch is used to activate a circuit which effectively extends the low frequency output of the amplifier.

17 Tone controls

BASS control:

This control is used to increase or decrease the low frequency response. The "0" center click position produces a flat response. Rotating the control in the + direction increases the low frequency response. Conversely, rotating the control in the – direction decreases it.

MID control:

This control is used to increase or decrease the mid-range frequency response. The "0" center click position produces a flat response. Rotating the control in the + direction increases the mid-range frequency response. Conversely, rotating the control to the – direction decreases it.

TREBLE control:

This control is used to increase or decrease the high frequency response. The "0" center click position produces a flat response. Rotating the control in the + direction increases the high frequency response. Conversely, rotating the control in the – direction decreases it.

18 BALANCE control

This control is used to adjust the relative volume levels of the left and right speakers. Rotating the control in the R direction shifts the sound image to the right. Conversely, rotating the control in the L direction shifts the sound image to the left. Use this control to compensate for unbalanced listening conditions due to your furniture arrangement, speaker placement, etc.

19 CENTER LEVEL control

This control is used to increase or decrease the level of a center speaker, if one is connected.

20 REMOTE CONTROL sensor

This sensor is used to receive signals from the remote control transmitter.

USING THE REMOTE CONTROL TRANSMITTER

The remote control transmitter supplied with your amplifier is designed to control all the most commonly used features of the amplifier. If the CD, CDV player, tuner, turntable and cassette deck connected to your amplifier are YAMAHA components designed for remote control compatibility (components with an RS mark), then this remote control transmitter will also control various functions of each component. Please consult your YAMAHA dealer for information on which components are compatible with the remote control transmitter. Note that this Remote Control transmitter will directly operate any compatible YAMAHA CD/CDV player and some Tuners or Cassette Decks bearing the RS mark.

■ OPERATION KEYS

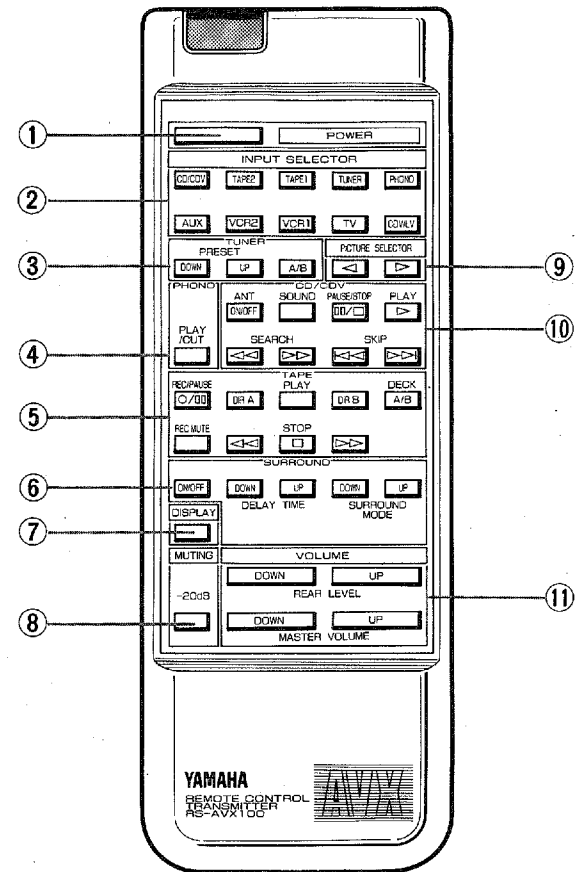

① **POWER key**

This key is used to turn this unit and any components connected to the switched outlets on and off.

② **INPUT selector keys**

These keys are used to select the source you wish to monitor.

③ **TUNER PRESET keys**

The A/B key is used to change the preset station range.
The UP and DOWN keys are used to select the preset station.

④ **PHONO PLAY/CUT key**

This key is used to control the start and stop operations of a turntable.

⑤ **TAPE deck control keys**

These keys are used to control the operations of a cassette tape deck.

REC/PAUSE key:

Press this key to put the deck into Rec Standby mode or Rec Pause mode.

DIR A key (for a double cassette deck only):

Press this key to change the tape running direction of DECK A.

PLAY key:

Press this key to start tape play or to begin recording from Rec Standby mode or Rec Pause mode.

DIR B (for a double cassette deck only):

Press this key to change the tape running direction of DECK B.

DECK A/B key (for a double cassette deck only):

Press this key to select which deck is to be operated, either DECK A or DECK B.

REC MUTE key:

Press this key to make a blank section during recording.

▶▶ and ◀◀ key:

These keys are used with a deck that has a Direction button. Press either the ▶▶ or ◀◀ key, the one pointing in the same direction as the Direction indicator, to fast-forward a tape. To fast-rewind a tape, press either the ▶▶ or ◀◀ key, the one pointing in the opposite direction as the Direction indicator.

If your deck has no Direction button, press the ▶▶ key to fast-forward a tape and press the ◀◀ key to fast-rewind a tape.

STOP key:

Press this key to stop a tape.

⑥ **SURROUND keys**

ON/OFF key:

This key has the same function as the SURROUND PROCESSING MODE ON/OFF button on the amplifier.

DELAY TIME UP and DOWN keys:

These keys have the same function as the SURROUND PROCESSING MODE DELAY TIME button on the amplifier.

SURROUND MODE UP and DOWN keys:

These keys are used to select the SURROUND PROCESSING MODE. Press the UP key to increase the number of the SURROUND PROCESSING MODE. Press the DOWN key to decrease the number of the SURROUND PROCESSING MODE.

⑦ **DISPLAY key**

Press this key to display the mode of this unit on the monitor screen.

When a picture is being monitored, the display is superimposed on the picture.

The display shows the settings of the INPUT (SOUND) SELECTOR, (INPUT) PICTURE SELECTOR, REC OUT SOUND, REC OUT PICTURE, MUTING, VIDEO ENHANCER, SURROUND MODE, DELAY TIME and REAR LEVEL.

When the display is not desired, press this key again.

⑧ AUDIO MUTING key

This key is used to reduce the output volume by 20 dB.

⑨ PICTURE selector keys

These keys are used to select the video source you wish to monitor.

⑩ CD/CDV control keys

These keys are used to control the operations of a compact disc player or a CD video player.

ANT key (for a CD video player only):

Press this key to select either the antenna input signal or the player signal.

SOUND select key (for a CD video player only):

Press this key to select the sound mode; STEREO, 1/L-CH, or 2/R-CH.

PAUSE/STOP key:

Press this key once to temporarily stop play and press it again to completely stop play.

PLAY key:

Press this key to start play.

SEARCH keys:

Press the ►► key to fast-forward play and press the ◀◀ key to fast-reverse play.

SKIP keys:

Press the ►►| key to advance to the beginning of the next selection.

Press the |◀◀ key to return to the beginning of the current selection.

When the |◀◀ is pressed at the beginning of a selection, play will start at the beginning of the previous selection.

⑪ VOLUME control keys

REAR LEVEL control keys:

These keys are used to increase or decrease the output level of the rear speaker pair.

MASTER VOLUME control keys:

These keys are used to increase or decrease the output volume level of both speaker pairs.

■ BATTERY INSTALLATION

The remote control unit uses 2 batteries (size "AA", R06). Install them according to the following illustration. Be sure that they are installed correctly.

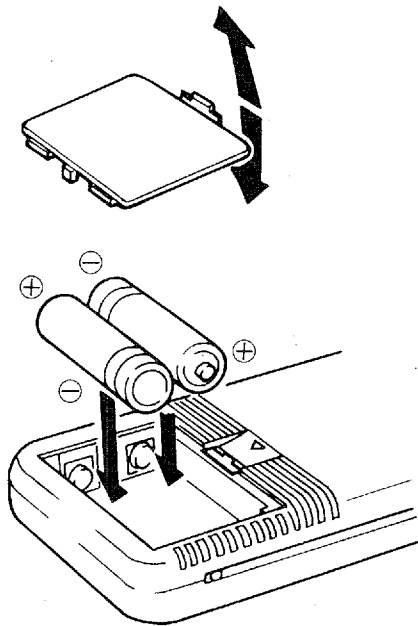

■ BATTERY REPLACEMENT

When the remote controllable distance decreases the batteries are exhausted. Replace with two new batteries. Install the batteries with the correct (+) and (-) polarities as indicated in the battery compartment.

BATTERY PRECAUTIONS

Incorrect use of a battery may result in personal injury or remote control transmitter damage. Be aware of the following measures:

- Read all safety labels on batteries.
- Do not use an old battery with a new one.
- Do not mix battery types (alkaline, heavy duty, carbon, nickel cadmium, etc.).
- When the remote control transmitter will not be used for a long period of time, remove the batteries and store them in a cool, dry place.
- Do not short circuit, heat, disassemble, or dispose of batteries into a fire.
- If leakage occurs, thoroughly wipe off all electrolyte residue from the battery compartment. Replace with new batteries.

BASIC OPERATIONS

■ OPERATION RANGE

You must point the remote control unit toward the amplifier and be within about 7 meters (23 feet) for proper operation.

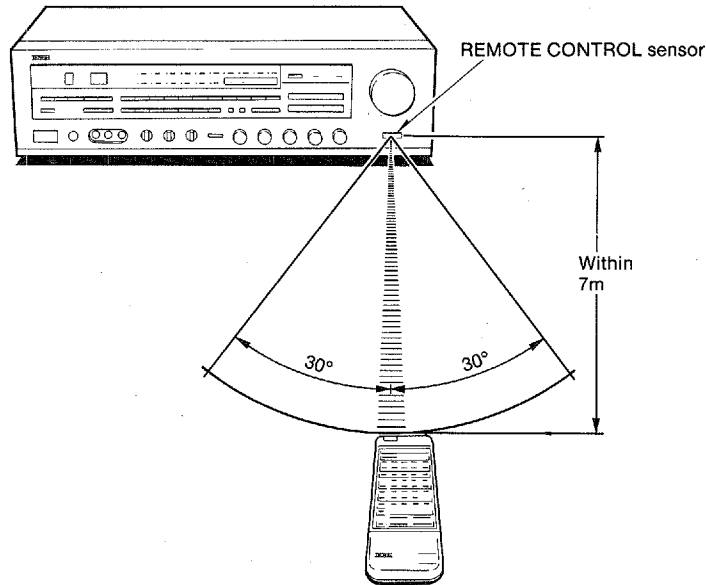

TO PLAY A PROGRAM SOURCE

1. Press the POWER switch to turn the unit ON.
2. For video sources, turn the TV monitor ON.
3. Select the program source to be heard or watched with the INPUT SELECTOR button.
 - When the sound of a video source is selected, the picture of that video source is automatically selected. If you wish to watch something other than it, press the PICTURE SELECTOR button to select the desired picture.
 - When only the sound of a video source is desired, press the PICTURE SELECTOR button until none of the PICTURE indicators is lit.
4. Play the program source.
5. Adjust the VOLUME control to increase or decrease the output volume level of all of the speakers.
6. Adjust the BASS, MID, and TREBLE tone controls for the corresponding frequency response.
7. Set the BASS EXTENSION switch. Setting this switch to ON boosts the low frequency response of the amplifier.
8. To use the Surround Processing mode, press the SURROUND PROCESSING MODE button and adjust the rear speakers level with the VOLUME REAR LEVEL keys on the remote control transmitter. When this unit drives a 5-speaker system, adjust the center speaker level with the CENTER LEVEL control.
For details on the surround processing mode, refer to "THE SURROUND PROCESSING MODE" described later.
9. Adjust the VIDEO ENHANCER buttons for a video source. For details on the video enhancer, refer to "USING THE VIDEO ENHANCER" described later.
 - Use the MUTING key on the remote control transmitter to lower the overall system volume to the -20 dB level. This lets you lower the volume (to answer the phone, for example) without disturbing the main volume setting.

■ TO SUPERIMPOSE THE CURRENT MODE OF THIS UNIT ON THE PICTURE

You can see the current mode at a glance without checking the settings of the controls. Three superimposition modes are available: DISPLAY OFF, FULL (which displays the superimposed settings indefinitely), and DISPLAY SHORT (which displays the superimposed settings for a few seconds before turning them off automatically).

Full display

1. Press the DISPLAY key on the remote control transmitter. The display on the monitor screen will show the settings of the INPUT (SOUND) SELECTOR, (INPUT) PICTURE SELECTOR, REC OUT SOUND, REC OUT PICTURE, MUTING, VIDEO ENHANCER, SURROUND MODE, DELAY TIME and REAR LEVEL.
2. To make the display disappear, press the DISPLAY key twice.

Short display

Press twice the DISPLAY key on the remote control transmitter. The display on the monitor screen will show the settings of the INPUT (SOUND) SELECTOR, (INPUT) PICTURE SELECTOR, REC OUT SOUND, REC OUT PICTURE, MUTING, VIDEO ENHANCER, SURROUND MODE, DELAY TIME and REAR LEVEL. The display will automatically disappear after a few seconds.

- When REC OUT SOUND, REC OUT PICTURE, INPUT SELECTOR, PICTURE SELECTOR, ENHANCER REC or MONITOR, or SURROUND PROCESSING MODE is pressed, the corresponding mode will be displayed on the screen without pressing the DISPLAY key.

RECORDING

This unit allows you to record; an audio or video program source, the video portion of one source mixed with the audio portion of another video program source (or another audio program source), or only the video or audio portion of a video program source.

1. Press the POWER switch to turn the unit ON.

2. **To record an audio program source**

Select the audio program source to be recorded with the REC OUT SOUND selector.

To record a video program source

Select the video program source to be recorded with the REC OUT SOUND selector and the REC OUT PICTURE selector.

To record the video portion of a video program source mixed with the audio portion of another video program source, or with another audio program source

Select the video portion to be recorded with the REC OUT PICTURE selector, and an audio portion of a video program source or an audio program source to be recorded with the REC OUT SOUND selector.

To record only the audio or video portion of a video program source

Select the desired audio or video portion to be recorded with the REC OUT SOUND or REC OUT PICTURE selector, and press either the REC OUT SOUND OFF or REC OUT PICTURE OFF selector for the portion not to be recorded.

3. Play the program source to be recorded and set the tape deck or video cassette recorder to record mode.
 - When you wish to listen to and/or watch the same source you are recording, select the corresponding source with the INPUT SELECTOR and/or PICTURE SELECTOR button(s).
 - During recording, with a 3-head type of cassette deck, the just-recorded sound may be heard by setting the INPUT SELECTOR button to the corresponding TAPE 1 or TAPE 2 position. During VCR recording, the sound and picture which is being sent to the VCR may be heard and watched by setting the INPUT SELECTOR and PICTURE SELECTOR buttons to the corresponding VCR 1 or VCR 2 position.
 - Since the REC OUT SOUND and REC OUT PICTURE selectors are independent from the INPUT SELECTOR and PICTURE SELECTOR buttons, you can listen to and/or watch a source other than the one you are recording. Select the desired source with the INPUT SELECTOR and/or PICTURE SELECTOR button(s).
 - Use the VIDEO ENHANCER buttons to adjust the video of a source. For details on the video enhancer, refer to "USING THE VIDEO ENHANCER" described later.
 - The settings of the SURROUND PROCESSING MODE buttons, CENTER LEVEL control, VOLUME, BALANCE controls, BASS EXTENSION, and tone control buttons do not affect the recording.

■ EDITING A TITLE

You can edit a title and superimpose it on your picture. The SURROUND PROCESSING MODE buttons are used for the TITLE EDIT operations.

1. Turn the TV monitor on.
2. Press the TITLE EDIT button for more than 1 second, until the blinking TITLE EDIT indicator lights steadily.

The screen shows three cursor lines and a character line (Edit mode).

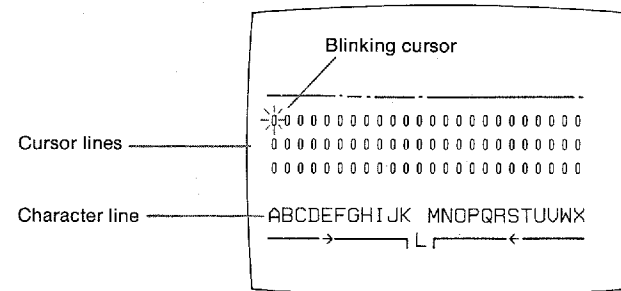

* The following characters can be input.

ABCDEFGHI JKLMNOP
 QRSTUVWXYZ abcdef
 ghijklmnopqrstuv
 wxyz012345678901
 23456789 äüö ! # % ? &
 + - * / = < > [] : ' , . , ♪ ♡
 → ← ↑ ↓ ⇄ ⇄ ⇄ | □ ◻

USING THE VIDEO ENHANCER

9. Press the 1/5 button to make the title invisible. Press this button again whenever you wish to superimpose the title on the picture to be recorded.

To delete or correct a character, or to clear the contents of a title

* Only when the 1/5 button is not pressed (Edit mode), can a character be changed or the title be cleared. When the screen shows only the title (Set mode), press the TITLE EDIT button until the screen shows the Edit mode.

● **To delete a character**

1. Move the cursor to the character to be deleted with the 3/7 or 4/8 button.
2. Press the 1-4/5-8 button to delete the character.

● **To correct a character**

1. Move the cursor to the character to be corrected.
2. Select the character to be input with the DELAY TIME UP/DOWN button.
3. Press the 2/6 button to input the selected character.

● **To clear the title**

Press the ON/OFF button for more than 1 second. All characters of the title will be cleared.

The Video Enhancer circuit is designed to improve the image quality of any video signal, during viewing, recording, or dubbing.

The Video Enhancer boosts the high frequency information, enabling it to increase both detail and sharpness. Since the image enhancement is proportional to the source material quality, the better the original, the greater the improvement.

Poor source material can be enhanced with only minimal results. This is due in part to the fact that video noise (snow) is in the same frequency range as detail and sharpness, so that when you enhance detail and sharpness, you also enhance snow. (Snow is comparable to hiss in a high fidelity audio system.)

Detail and sharpness are inter-related, but distinct, aspects of picture quality. A lack of detail shows up as smeared pictures or pictures lacking in subtle texture, while a lack of sharpness shows up as indistinct lines and edges.

When recording from a camera or television tuner, use the Video Enhancer to exaggerate detail. This will pre-compensate for the loss of quality due to the recording and process, and produce a tape with all of the original details.

When making tape duplicates, use the Video Enhancer to retain most of the original's detail and sharpness. If the original is extremely snow-free, the copy can look better.

When viewing a video tape recording, use the Video Enhancer to compensate for a loss of quality due to the video cassette recorder.

CONTROLS

The ENHANCER REC and MONITOR buttons are used to select the signal to be enhanced. When the MONITOR button is pressed, video enhancing is performed on the video source signal being monitored. When the REC button is pressed, video enhancing is performed on the video signal going to a video cassette recorder. If this button is pressed during video recording, the picture will go blank for a few moments. The DETAIL control is used to compensate for detail loss. Use it to exaggerate detail before recording and/or to restore detail during playback. Turn the control completely counterclockwise to eliminate its effect. Turn it clockwise to adjust for natural detail and acceptable snow. The SHARPNESS control is used to increase the sharpness of the picture, and to also bring up some detail.

This control has no effect on the video signal when it is in center position. Turn the control completely counterclockwise to eliminate its effect. Turn it clockwise to adjust for maximum sharpness without creating false outlines.

The VIDEO LEVEL control is used to control the overall level of the video signal from a source. It is similar to the brightness control on your television. This control has no effect on the video signal when it is in the center position. Turn it clockwise to increase the video signal level and counterclockwise to decrease it.

- These controls do not affect the signals at the S connectors.

CHECK THE EFFECT OF EACH CONTROL

To obtain the best results from the Video Enhancer, you should first check the effect of each control separately, as well as their interaction.

1. Make sure all of the controls are set to their defeat positions, and that the ENHANCER MONITOR button is pressed.

2. Select a broadcast program to obtain a high-quality source image. Remember, the better the source, the more obvious the enhancement.
3. Turn the VIDEO LEVEL control and note its effect. The image becomes brighter as you turn the control clockwise and darker as you turn it counterclockwise. Set it to a desirable level and note its position.
4. To judge the improvement, press the ENHANCER MONITOR button on and off to compare the before and after enhancement images.
5. Return the VIDEO LEVEL control to the center position.
6. Turn the SHARPNESS control and note its effect. The edges and contours of objects and people should increase in sharpness as you turn the control clockwise. If you continue to turn the control clockwise, sharpness will be exaggerated and false outlines will be created. Turn it back to a desirable level, where the outlines are acceptable and the images natural. Note the position of the control.
7. To judge the improvement, press the ENHANCER MONITOR button on and off to compare the before and after enhancement images.
8. Return the SHARPNESS control to the extreme counterclockwise position.
9. Turn the DETAIL control and note its effect. The texture of clothes, distant background, and people should increase in detail as you turn the control clockwise. If you continue to turn the control clockwise, detail will become coarse and the picture will have increased snow. Turn it back to a desirable level, where the snow is acceptable and the detail natural. Note the position of the control.
10. To judge the improvement, press the ENHANCER MONITOR button on and off to compare the before and after enhancement images.
11. Return the DETAIL control to the extreme counterclockwise position.

VIEWING

Before using the Video Enhancer for viewing, make sure that all of the controls are in their defeat positions, and that the ENHANCER MONITOR button is pressed. The correct sequence of adjustment is Video Level, Sharpness, and then Detail. Judge the enhancement results from your usual viewing distance. When you view a television broadcast, the amount of improvement depends on the quality of the broadcast. Some broadcasts are already enhanced and will not require further enhancing, while other broadcasts may require detail and/or sharpness enhancement.

When you view a video tape recording, use the Video Enhancer to substantially improve a non-enhanced tape, or to slightly improve an enhanced tape.

- **Video Level**

Adjust the VIDEO LEVEL control until the image is of acceptable brightness.

- **Sharpness and Detail**

Quality television broadcast images require no, or very little, sharpness enhancement. Turn the DETAIL control clockwise to emphasize the detail of the image with increased clarity. Turn the DETAIL control counterclockwise to decrease clarity. Look at the surface areas of objects to determine the effect.

- **Interaction**

Make minor adjustments to all of the controls, if necessary, to obtain the best result.

- **Note:**

There is always a tendency to over-enhance the viewing image. The picture may seem better, but is actually worse in some respects. To compensate for this tendency, turn the Video Enhancer off and on as you adjust the controls and compare the before and after enhancement images. If you are in doubt, the image is probably over-enhanced. Turn the controls back until you see the best image.

Also, with some televisions, using a lot of enhancement may affect the vertical stability of the picture.

RECORDING

Use the Video Enhancer to exaggerate detail and sharpness before recording, to compensate for the picture degradation that will occur due to the recording process. Do not over-enhance, as the video cassette recorder may cause the image to tear or color shift. To determine the best control settings, make short test recordings before attempting a full length recording. Begin with the levels set for the best viewing and with the ENHANCER REC button pressed, then increase the detail and sharpness control levels for each test. Play the test recordings back to determine the best settings.

This enhancement will increase the coarseness and snow in the viewing picture. However, these effects will not appear during playback of the recording. These tests may be time-consuming, but will become less necessary as you become more familiar with the Video Enhancer.

USING THE SURROUND SOUND PROCESSOR

DUBBING

You should use the Video Enhancer every time you dub a video tape. In this way you can enhance before the tape loss, and only have to use a small amount of enhancement. This method also minimizes the amount of snow and image coarseness on the final copy. Always try to balance snow and picture improvement on low-quality recordings.

On successive generations, detail deteriorates more than sharpness, so that a lot of detail enhancement may be necessary, and very little sharpness enhancement. A many-generation tape may have no detail and lack sharpness. In this case, it is unlikely that you will be able to obtain a high quality picture, but considerable improvement is possible.

This unit incorporates a sophisticated, multi-mode digital surround sound processing amplifier, which allows you to expand and shape the audio sound field from both the audio and video sources, for a theater-like experience in the listening/viewing room.

The surround sound processor has 8 processing modes and an independent DELAY TIME button which functions in conjunction with all 8 of the surround modes. There are six modes for stereo sources. Two modes for monaural sources are also included.

Please review the following descriptions of the surround processing modes and DELAY TIME button, and select the best effect according to your preference.

In addition, the rear speaker placement allows you to experience various atmospheres of the sound field. Select the best placement for the rear speakers by referring to "REAR SPEAKER REPLACEMENT" and the character of each surround mode described later.

■ REAR SPEAKER PLACEMENT

The placement of the rear speakers in the listening room will greatly affect the overall sound field created. A small pair of speakers is all that is really required to create the full effect, and the most basic speaker placement configuration is shown in Fig. A.

This setup is ideal for creating a theaterlike atmosphere for movies and other video programs.

The "B" setup creates a sound field with added depth, much like that experienced in a live concert hall, where most of the sound is coming at you from the front. It is most appropriate for musical sources, rather than videos.

The "C" speaker placement configuration effectively "widens" the sound field, and is suitable for movies and other video programs.

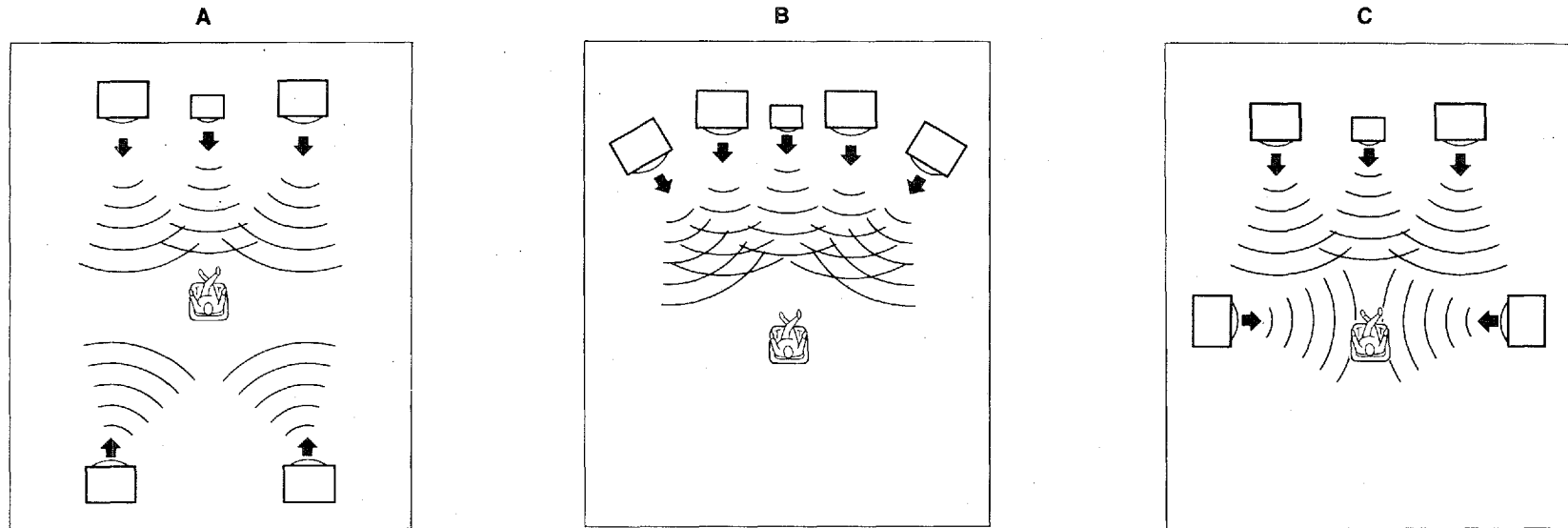

While the most basic speaker placement setup is recommended at first, by experimenting with different speaker placements for each musical or video source, and with each surround mode, you will be able to create a wide variety of sound field effects suited to your listening environment and to your own particular tastes.

Note on the center speaker

When a center speaker is used, vocals and dialogs can be concentrated, so that the sound will be more real, and the acoustic image more energetic and stable.

1 NATURAL SUR. 1

The original Yamaha Natural Surround mode is used to create a surround effect for video signals not encoded in Dolby Surround. Background and reverberant sounds are sent solely to the rear speakers. This mode is especially effective with programs that have a lot of reverberation. The acoustic image center is firmly located and centered between left and right front speakers.

Localization center

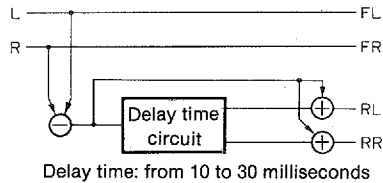
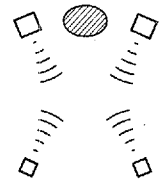

3 HALL SURROUND

In this mode, the center seems even more deeply behind the front speaker pair, creating an expansive, large hall ambience. The apparent listening position is toward the center of the hall rather than directly in front of the stage.

Localization center

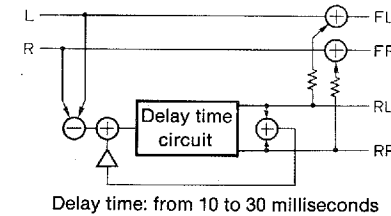

2 NATURAL SUR. 2

This mode is, of course, similar to NATURAL SUR. 1 except that a slight amount of the effect sounds are mixed with the main program and send to the front speakers. The sonic result is a wider, expanded sound image, with the center sound seeming to come from slightly behind the front speakers.

Localization center

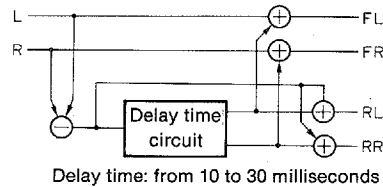
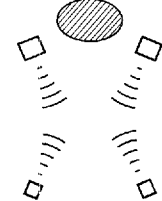

4 DOLBY SURROUND™ DOLBY SURROUND

With a great number of movies made today, the sound track is specially encoded with Dolby surround sound, for playback in movie theaters equipped with Dolby processing surround sound systems. It is this that is responsible for the incredibly lifelike effect you experience at movie theaters: While the dialog comes at you from the front speakers, the sound effects, background noise, and other ambient noise in the sound track comes at you from behind as well. You are literally surrounded by sound. Dolby surround is encoded on the sound track of many commercially available video cassettes and video discs. When you play tapes encoded with Dolby surround on your home video system, the Dolby surround mode of this unit decodes the signal and feeds the sound effects, background noise, ambient noise, etc., through your rear speakers, so that the same surround effect experienced in the theater is experienced in your living room as well.

* Dolby surround mode will have no effect on video sources not encoded with Dolby surround.

Localization center

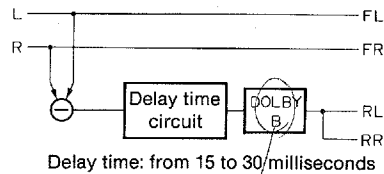
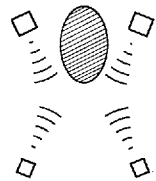

DOLBY
NR

5 SIMULATED STEREO

This mode is designed specifically to enhance mono program sources. Compared to a strictly mono setting, the sound image created in this mode is wider and slightly forward of the front speaker pair, lending an immediacy to the overall sound. It is particularly effective when used with old mono movies, news broadcasts and dialogue.

Localization center

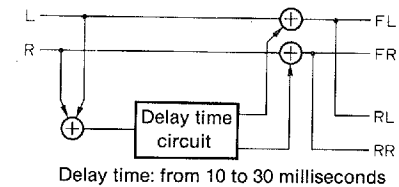
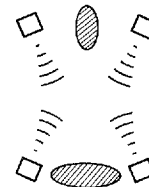

6 SIMULATED SUR. (SURROUND)

As with the SIMULATED STEREO mode, SIMULATED SUR. is designed to be used with mono sources. Compared to SIMULATED STEREO, however, this mode creates a more expansive sound image, and can be used to advantage even with some stereo programs.

Localization center

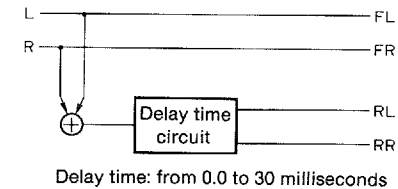
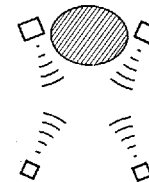

7 LIVE SURROUND

This mode takes advantage of a delayed signal and feedback circuit in the rear effect speakers to create a bright, lingering, and somewhat resonant sound that characterizes a small concert space.

Localization center

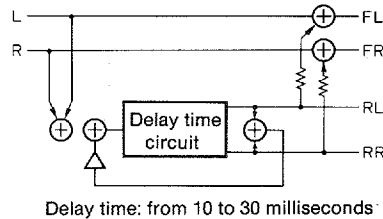
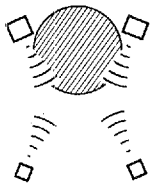

8 PRESENCE DELAY

In comparison to other surround settings, the reverberation signal in the rear is quite dominant. For programs with little to no reverberant content, adjustment of the delay time is recommended to achieve the optimum sound. Using this mode on programs with a relatively high reverberant content could result in a muddy sound.

Localization center

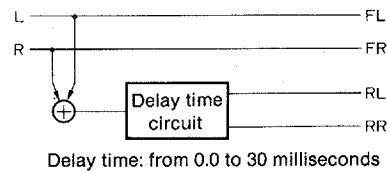
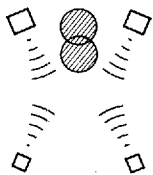

● DELAY TIME UP/DOWN button

The DELAY TIME UP/DOWN button is effective with all modes. It provides for continuously variable control over the delay time.

- 1 NATURAL SUR. 1: from 10 to 30 milliseconds
- 2 NATURAL SUR. 2: from 10 to 30 milliseconds
- 3 HALL SURROUND: from 10 to 30 milliseconds
- 4 DOLBY SURROUND: from 15 to 30 milliseconds
- 5 SIMULATED STEREO: from 10 to 30 milliseconds
- 6 SIMULATED SUR.: from 0.0 to 30 milliseconds
- 7 LIVE SURROUND: from 10 to 30 milliseconds
- 8 PRESENCE DELAY: from 0.0 to 30 milliseconds

By applying more or less delay, sound effects, background noise, and ambient noise coming at you from the rear speakers can be enhanced or subdued for extra effect. Adding too much delay will cause an unnatural effect with some sources. Experiment with the DELAY TIME UP/DOWN button to create an effect that you find most suitable.

- * The last setting of the DELAY TIME button is memorized even when the power is turned off.
- * The surround sound processor is effective only when this unit is used in a 4-speaker or 5-speaker system setup. Refer to the "REAR SPEAKER REPLACEMENT" described later.

SPECIFICATIONS

AUDIO SECTION

Minimum RMS Output Power per Channel

MAIN IN A

8 ohms, 20 Hz to 20 kHz, 0.01% THD	65W
6 ohms, 20 Hz to 20 kHz, 0.01% THD	70W
8 ohms, 1 kHz, 0.01% THD	70W

MAIN IN B

8 ohms, 1kHz, 0.01% THD	14W
6 ohms, 1 kHz, 0.01% THD	15W

Dynamic Power per Channel (by IHF)

MAIN IN A

8 ohms	85W
6 ohms	105W

MAIN IN B

8 ohms	18W
6 ohms	20W

Dynamic Headroom

MAIN IN A

8 ohms	1.2 dB
6 ohms	1.8 dB

MAIN IN B

8 ohms	1.1 dB
6 ohms	1.2 dB

Damping Factor (1 kHz, 8 ohms)

MAIN IN A	More than 90
MAIN IN B	More than 40

Input Sensitivity/Impedance

PHONO MM	2.5 mV/47 k-ohms
CD etc.	150 mV/47 k-ohms
MAIN IN A	1V/33 k-ohms
MAIN IN B	340 mV/33 k-ohms

Input Sensitivity (New IHF)

PHONO MM	0.353 mV
CD etc.	21.2 mV

Maximum Input Level

PHONO MM, 1 kHz	100 mV
-----------------	--------

Output Level/Impedance

REC OUT	150 mV/100 ohms
PRE OUT	1V/1 k-ohms

Maximum Voltage Output

20 to 20 kHz, 0.001% THD	5V
--------------------------	----

Headphone Jack Rated Output/Impedance

0.1% THD, 1 kHz, RL = 100 ohms	2.2V/100 ohms
--------------------------------	---------------

Frequency Response

40 Hz to 20 kHz, CD etc.	0 ± 1 dB
20 Hz to 20 kHz, MAIN IN	0 ± 1 dB

RIAA Equalization Deviation

PHONO MM	± 0.5 dB
----------	----------

Total Harmonic Distortion

(20 Hz to 20 kHz)

PHONO MM, 1V	Less than 0.005%
CD etc. to Pre Out, 3V	Less than 0.005%
MAIN IN A to Sp Out, 35W/8 ohms	Less than 0.005%

(20 to 10 kHz)

MAIN IN B to Sp Out, 7W/8 ohms	Less than 0.01%
--------------------------------	-----------------

Signal to Noise Ration (IHF-A Network)

PHONO MM (5 mV Input Shorted)	More than 86 dB
CD etc. (Shorted)	More than 96 dB
MAIN IN A (Shorted)	More than 120 dB
MAIN IN B (Shorted)	More than 106 dB

Signal to Noise Ratio (New IHF)

PHONO MM	75 dB
CD etc.	77 dB

Residual Noise (IHF-A Network)

	200 μV
--	--------

Channel Separation (Vol. -30 dB, 1 kHz/10 kHz)

PHONO MM input shorted	65 dB/50 dB
CD etc. input 5.1 k-ohms terminated	65 dB/50 dB

Tone Control Characteristics

Bass
boost/cut ± 10 dB (50 Hz)
turnover frequency 350 Hz

TREBLE
boost/cut ± 10 dB (20 kHz)
turnover frequency 3.5 kHz

MID
control range ± 10 dB (1 kHz)
center frequency 1 kHz

Filter Characteristics

Subsonic (Built-in) 20 Hz, 12 dB/oct

Audio Muting -20 dB

Gain Tracking Error (0 to -60 dB) Less than 3 dB

Bass Extension (70 Hz) +7 dB

VIDEO SECTION

Video Signal Type NTSC

Horizontal Resolution 525 lines, 60 field

Video Input 1.0 Vp-p, 75 ohms, Unbalanced

Video Output 1.0 Vp-p, 75 ohms, Unbalanced

Maximum Input Level 1.5 Vp-p, 75 ohms, Unbalanced

Video Signal-to-Noise Ratio More than 50 dB

Detail Control Level -6 to 0 to +3 dB (1 MHz)

Sharpness Control Level 0 to +10 dB (2 MHz)

Video Level Control -3 to 0 to +3 dB

S Video Input 1 Vp-p, 75 ohms, Unbalanced (Input-Y)

0.3 Vp-p, 75 ohms Unbalanced (Input-C)

S Video Output 1 Vp-p, 75 ohms, Unbalanced (Output-Y)

0.3 Vp-p, 75 ohms, Unbalanced (Output-C)

GENERAL

Power Supply AC 120V, 60 Hz

Power Consumption 350W

AC Outlet

Switched x 2 100W max (Total).

Unswitched x 1 200W max.

Dimensions (W x H x D) 435 x 126 x 340 mm
(17-1/8" x 4-15/16" x 13-3/8")

Weight 9.6 kg (21 lbs. 3 oz.)

Supplied Accessories Mini plug cord x 1

Remote control cable (5P) x 1

Remote control cable (6P) x 1

Video cord x 1

Audio cord x 1

Infrared remote control transmitter x 1

"AA" size battery x 2

Specification subject to change without notice.

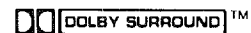

Manufactured under license from Dolby Laboratories Licensing Corporation. Additionally licensed under one or more of the following patents: U.S. numbers 3,632,886, 3,746,792, and 3,959,590; Canada numbers 1,004,603 and 1,037,877. "Dolby" and the double-D symbol are trademarks of Dolby laboratories Licensing Corporation.

TROUBLESHOOTING

If the unit fails to operate normally, check the following points to determine whether the fault can be corrected by the simple measures suggested. If it cannot be corrected, or if the fault is not listed in the SYMPTOM column, disconnect the power cord and contact your dealer or authorized YAMAHA Preferred Customer service center for help.

SYMPTOM	CAUSE	REMEDY
The amplifier fails to turn on when the POWER switch is pressed.	<ul style="list-style-type: none"> ● Power cord is not plugged in or is not completely inserted. 	<ul style="list-style-type: none"> ● Firmly plug in the power cord.
No sound.	<ul style="list-style-type: none"> ● Incorrect output cord connections. 	<ul style="list-style-type: none"> ● Connect cord properly. If the problem persists, the cables may be defective.
	<ul style="list-style-type: none"> ● Incorrect amplifier control setting. 	<ul style="list-style-type: none"> ● Set the amplifier controls to the correct input source.
Sound "hums".	<ul style="list-style-type: none"> ● Incorrect cable connections. 	<ul style="list-style-type: none"> ● Firmly connect the audio plugs. If the problem persists, the cord may be defective.
No picture.	<ul style="list-style-type: none"> ● Incorrect cord connections. ● Wrong video unit selected. ● Video unit not turned on. 	<ul style="list-style-type: none"> ● Connect the video plugs correctly. ● Select correct video unit. ● Turn video unit on.
Enhance controls have no effect.	<ul style="list-style-type: none"> ● ENHANCER REC or MONITOR button in wrong position. 	<ul style="list-style-type: none"> ● Select correct ENHANCER REC or MONITOR position.
Enhance controls worsen picture.	<ul style="list-style-type: none"> ● SHARPNESS or DETAIL control set too high. 	<ul style="list-style-type: none"> ● Set SHARPNESS and DETAIL controls to a lower level.
	<ul style="list-style-type: none"> ● Poor source quality. 	<ul style="list-style-type: none"> ● Obtain better source material.

YAMAHA

YAMAHA CORPORATION
10-1, Nakazawa-cho, Hamamatsu, 430 Japan

VF27420-0

BWgg.G  Printed in Japan